

PRICE BOOK

July 1, 2019



ALARM LOCK

ALARM LOCK SYSTEMS, LLC

345 Bayview Ave.
Amityville, NY 11701
1-800-ALA-LOCK (252-5625)
(631) 789-4871 Tel or (631) 789-3383 Fax



Price Book 2019

Important Things to Know about Doing Business with Alarm Lock Systems, LLC.

Prices shown in this book are list prices. All customers with direct accounts receive a discount letter along with each new price book. If you have a direct account with Alarm Lock you may request a copy of your discount letter in writing or by contacting you local sales representative.

The price book is for pricing purposes only and does not represent stocking levels. Certain items are manufactured to order. Please be sure to consult the factory or your Alarm Lock representative or Regional Sales Manager for availability.

Terms: Net 30

Freight Allowance: Shipments are F.O.B. Amityville, NY. Freight allowed within the continental U.S.A. is \$7,500.00. **Freight allowance not available on drop ship orders.**

Drop Shipments: All orders shipping to an address other than the customer's or one of their branches, is subject to a \$25.00 handling fee. **Freight allowance not available on drop ship orders.**

Minimum Order: The minimum order requirement has been changed to \$250.00 for all customers.

Returns/Warranty: Please see last page of price book for details.

Website: Visit us at www.alarmlock.com for a complete list of sales representatives by state, product specifications, technical data, and downloadable PDF files of all Alarm Lock's products as well as the most current version of our software DL-Windows.

If you need to contact us:

Alarm Lock Systems, LLC.
345 Bayview Ave
Amityville NY 11701

Toll free number – 1 800 ALA-LOCK (252-5625)
Direct telephone – 631 789-4871
Direct fax – 631 789-3383

All prices published are suggested list prices in US Dollars. Some specifications are preliminary and subject to change without prior notice. Not responsible for typographical errors. Alarm Lock Systems, LLC, is a Division of Napco Security Technologies, Inc. (NASDAQ:NSSC) © Alarm Lock Systems, LLC, 9.16



Table of Contents

Trilogy DL2700/DL2700LD	100 user Lock/LocDown.....	6
Trilogy DL5200	100 user Double Sided Lock.....	7
Trilogy DL2700CR/DB T2 Series	8-9
Trilogy ETDL27 Series	10-12
Trilogy DL2800	200 user Lock.....	13
Trilogy DL3000	300 user Lock.....	14
Trilogy DL3200	2000 user Lock.....	15
Trilogy DL5300	2000 user Double Sided Lock.....	16
Trilogy DL4100	2000 user Privacy/Residency Lock.....	17
Trilogy PDL3000	2000 user Proximity & Keypad Lock.....	18
Trilogy PDL5300	2000 user Proximity Double Sided Lock.....	19
Trilogy PL3000	2000 user Proximity Only Lock.....	20
Trilogy PDL4100	2000 user Proximity w/Privacy/Residency Lock.....	21
Trilogy Cylindrical Lock Parts.....	22-23
Trilogy & Networx Remote Release Products	24
Trilogy DL3500	300 user Mortise Lock25-26
Trilogy DL4500	2000 user Mortise w/Privacy/Residency Lock.....	27
Trilogy PL/PDL3500	2000 user Proximity Mortise Lock28-29
Trilogy PDL4500	2000 user Proximity Mortise w/Privacy/Residency Lock.....	30-31



Table of Contents (con't)

Trilogy DL1200 100 user Narrow stile Lock.....32

Trilogy DL1300 2000 user Narrow Stile Lock.....33

Trilogy PDL1300 2000 user Narrow Stile Proximity Lock.....34

Trilogy Narrow Stile Lock Parts & Accessories.....35

Trilogy DL1200ET, DL/PDL1300ET Narrow Stile Exit Trim.....36-37

Trilogy Narrow Stile Exit Trim Parts & Accessories.....38

Trilogy ETDL/ETPDL 2000 user Exit Trim Lock.....39-41

Trilogy DK3000 2000 user Keypad/Wall Mounted Reader.....42

Trilogy PDK3000 2000 user Proximity Keypad/Wall Mounted Reader42

Trilogy DL6100 Networx Digital Lock, 5,000 user codes43

Trilogy PDL6100 Networx Proximity & Keypad 5,000 user codes44

Trilogy Training Options 45

Trilogy PL6100/PDL6200 Networx Proximity Only 5,000 user codes46

Trilogy DL6500 Networx Digital Mortise Lock 5,000 user codes47

DL 6500 Mortise Lock Accessories48

Trilogy PDL6500/PL6500 Networx Proximity and Prox Only 5,000 user codes49

PDL6500/PL6500/PDL6600 Mortise Lock Accessories50

PDL8200/PDL8600 iClass Networx Locks and Accessories.....51-53

DL/PDL6300 Networx Double Sided Locks.....54

Trilogy Networx Gateways55

DL1300NW Networx Narrow Stile Lock56

PDL1300NW Networx Narrow Stile Lock.....57

Networx Narrow Stile Lock Accessories.....58



Price Book 2019

DL/PDL1300ETNW Networx Narrow Stile Exit Trim.....59-61

ETDLN/ETPDN/ETPDNI (and SRX)62-64

NETDK/NETPDK Networx Digital wireless Keypad65-66

Trilogy Remote Release67

Networx Upgrade Kits68

ArchiTech™ Series Locks and Accessories69-74

Weather Resistant Alarmed Panic Devices.....75

Alarmed Panic Devices.....76

Door Alarms.....77

Delayed Egress Panic Device.....78

Electric Deadbolts.....78

Remote Release Mags.....79

Power Magnets.....79-80

Alarm Lock Warranty/Return Policy81



TRILOGY ELECTRONIC DIGITAL LOCKS

DL2700 SERIES – Electronic battery operated digital lock. Holds up to 100 user codes, 1 Master, 10 Manager codes & up to 3 one time user codes.

SPECIFICATIONS:



DL2700



DL2700LD** (LocDown™)

**Standard model is weather-resistant

Door Thickness: Fits 1 5/8" to 1 7/8". Other thickness, refer to chart to the right.
Backset: 2 3/4" (2 3/8" also available. Must specify when ordering)
Strike: 1 1/8" x 2 3/4" T strike & 1 1/4" x 4 7/8" ASA strike included
Latch bolt: UL Listed, fire rated 3 hours, 1/2" throw, reversible
Handing: Non-handed
Power: 5 AA alkaline batteries (included)
Keypad: All metal, 12 button. All functions programmed through keypad
Door Prep: Standard ANSI A115 Series prep, modified by adding additional through-bolt holes
Compliances: BHMA Certified Grade 1 heavy duty cylindrical lockset
 UL Listed 10C Positive Pressure Specification. FCC Certified
 ADA compliant levers
Cylinder: 6 pin solid brass. SCY1 keyway furnished with all key override loc
 Schlage, Corbin-Russwin CL, Sargent 480 series, ASSA 65-611 & Lori cylinders can be used with the HW620 tailpiece (supplied)
Interchangeable Core Models: Standard model accepts 6 & 7 pin cylinders from Best, Falcon, Arrow, KSP, Medeco Keymark & Kaba Peaks.
 IC core models prepped for 6 & 7 pin Yale and Corbin-Russwin
 IC core models prepped for 6 pin Medeco, Sargent, and Schalte

Extended sizes:

WP standard and SFIC cylinder preps can be extended for thicker doors.

\$165.00 add on to list for extended lock.

Extended lock legend:

- W54 - 2 1/8"
- W57 - 2 1/4"
- W60 - 2 3/8"
- W64 - 2 1/2"
- W70 - 2 3/4"
- W76 - 3"
- W83 - 3 1/4"
- W89 - 3 1/2"

Note: Locks can be adjusted by +/- 1/8" by adding or removing spacers.

PLEASE CHECK WITH FACTORY FOR LEAD TIMES ON SPECIAL FINISHES AND IC PREPS
 SPECIFY "WP" FOR WEATHER-RESISTANT MODEL

PRODUCT	FINISH	LIST PRICE
DL2700	US26D	\$925.00
Standard key override	US3 & US10B	\$1,059.00
DL2775	US26D	\$988.00
Standard Key override	US3 & US10B	\$1,119.00
Regal (curved)		
DL2700IC*	US26D	\$962.00
Interchangeable core	US3 & US10B	\$1,079.00
DL2775IC*	US26D	\$1,025.00
Interchangeable core	US3 & US10B	\$1,096.00
Regal (curved)		
DL2700WP	US26D	\$1,012.00
Weather proof key override	US3 & US10B	\$1,076.00
DL2775WP	US26D	\$1,027.00
Weather proof key override	US3 & US10B	\$1,098.00
Regal (curved)		
DL2700WPIC*	US26D	\$1,027.00
Weather proof	US3 & US10B	\$1,062.00
Interchangeable core		
DL2775WIC*	US26D	\$1,048.00
New Regal (curved) lever	US3 & US10B	\$1,098.00
Interchangeable core		
DL2700LD	US26D	\$973.00
Standard Key override	US10B	\$1,001.00
DL2700LDIC	US26D	\$1,006.00
Interchangeable core	US10B	\$1,022.00

*Add "C" for Corbin, "M" for Medeco, "R" for Sargent, "Y" for Yale and "S" for Schlage to end of the part number for specially prepped IC core models. Add \$15.00 to the list price shown above. **MUST SPECIFY 7 PIN FOR CORBIN AND YALE** For small format Medeco IC, specify SFIC prep. DL2700 mounted sample available. Consult factory.



TRILOGY ELECTRONIC DOUBLE SIDED DIGITAL LOCKS

DL5200 SERIES – Double sided electronic battery operated digital lock. Holds up to 100 user codes, 1 Master, 10 Manager codes & up to 3 one time user codes. Programmable keypad on both sides of the door. Key override is only operable on the primary side. The key on the secondary side is used only to remove the lever and access the batteries.

SPECIFICATIONS:

Door Thickness:	Fits 1 5/8" to 1 7/8".
Backset:	2 3/4" (2 3/8" also available. Must specify when ordering)
Strike:	1 1/8" x 2 3/4" T strike & 1 1/4" x 4 7/8" ASA strike included
Latch bolt:	UL Listed, fire rated 3 hours, 1/2" throw, reversible
Handing:	Non-handed
Power:	4 AA alkaline batteries (included)
Keypad:	All metal, 12 button. Basic functions programmed through keypad
Door Prep:	Standard ANSI A115 Series prep, modified by adding additional through-bolt holes
Compliances:	BHMA Certified Grade 1 heavy duty cylindrical lockset UL Listed 10C Positive Pressure Specification. FCC Certified ADA compliant levers
Cylinder:	6 pin solid brass. SCY1 keyway furnished with all key override locks Schlage, Corbin-Russwin CL, Sargent 480 series, ASSA 65-611 & Lori cylinders can be used with the HW620 tailpiece (supplied)
Interchangeable Core Models:	Standard model accepts 6 & 7 pin cylinders from Best, Falcon, Arrow only



All DL5200 locks are weather-resistant. Please consult with the factory for lead times on special finishes.

PRODUCT	FINISH	LIST PRICE
DL5200 Standard key override	US26D US3 & US10B	\$1,559.00 \$1,630.00
DL5275 Standard Key override Regal (curved)	US26D US3 & US10B	\$1,589.00 \$1,655.00
DL5200IC Interchangeable core	US26D US3 & US10B	\$1,583.00 \$1,655.00
DL5275IC Interchangeable core Regal (curved)	US26D US3 & US10B	\$1,600.00 \$1,684.00
DL5200SK	Mounted DL5200 demo	Call Factory

Note: Key override operates latch on primary side only. Key override on secondary side protects the battery pack.



Price Book 2019

ALARM LOCK TRILOGY T2 SERIES MORTISE LOCK

DL2700CR/DB series – Trilogy T2 keyless access lock for mortise door prep. Holds up to 100 use codes, 1 master, 10 manager codes and up to 3 one time user codes.

SPECIFICATIONS:

Door Thickness: Fits 1 5/8" to 1 7/8"
Backset: 2 3/4" standard
Strike: 1 1/4" x 4 7/8" strike included
Handing: Specify RH or LH when ordering. Lock is reversible in the field.
Power: 5 AA alkaline batteries (included)
Keypad: All metal, 12 button. All functions programmed through keypad
Door Prep: Standard ANSI A115 mortise prep, modified by adding additional through-bolt holes
Compliances: Steelcase lock body meets BHMA specifications for Grade 1 locks
 UL Listed 10C Positive Pressure Specification. FCC Certified
 ADA compliant levers
Functions: Classroom function features stainless steel latch bolt With 3/4" (1.91cm) projection and deadlocking latch. Deadbolt function features stainless steel deadbolt with 1" (2.55cm) projection, latch bolt with 3/4" (1.91cm) projection and deadlocking latch. Deadbolt may be projected from key cylinder from outside door or turn-piece from inside door.
Cylinder: 1 3/8" (3.5cm) mortise cylinder supplied. Will accept 1 3/8" to 1 1/2" (3.5 - 3.8cm) mortise cylinder.
Cams: Classroom function supplied with straight cam. Deadbolt function supplied with cloverleaf cam. Cams for other manufacturer's cylinder are available. See 'Mortise Lock accessories' for part numbers & manufacturers.



**ALL DL2700CR/DB MORTISE LOCKS ARE WEATHER-RESISTANT
 PLEASE CHECK WITH FACTORY ON LEAD TIMES FOR SPECIAL FINISHES**

PRODUCT	FINISH	LIST PRICE
DL2700CRR	26D	\$1,054.00
Straight lever classroom Function right hand	10B	\$1,072.00
DL2700CRL	26D	\$1,054.00
Straight lever classroom Function left hand	10B	\$1,072.00
DL2700DBR	26D	\$1,054.00
Straight lever deadbolt Function right hand	10B	\$1,072.00
DL2700DBL	26D	\$1,054.00
Straight lever deadbolt Function left hand	10B	\$1,072.00
DL2775CRR	26D	\$1,072.00
Regal (curved) lever classroom Function right hand	10B	\$1,091.00
DL2775CRL	26D	\$1,072.00
Regal (curved) lever classroom Function Left Hand	10B	\$1,091.00
DL2775DBR	26D	\$1,072.00
Regal (curved) lever deadbolt Function right hand	10B	\$1,091.00
DL2775DBL	26D	\$1,072.00
Regal (curved) lever deadbolt Function left hand	10B	\$1,091.00



Price Book 2019

DL2700CR/DB TRILOGY MORTISE SERIES (con't)

DL2700CR/DB Parts

CLASSROOM FUNCTION CAMS	DESCRIPTION	LIST PRICE
HW956-L	Alarm Lock Standard Straight Cam	\$5.00
HW956-M	Marks Straight Cam	\$5.00
HW956-C	Corbin-Russwin Straight Cam	\$5.00
HW956-S	Schlage Straight Cam	\$5.00
HW956-A	Arrow Straight Cam	\$5.00
HW956-R	Sargent Straight Cam	\$5.00
DEADBOLT FUNCTION CAMS		
HW957-L	Alarm Lock Standard Cloverleaf Cam	\$5.00
HW957-M	Marks Cloverleaf Cam	\$5.00
HW957-C	Corbin-Russwin Cloverleaf Cam	\$5.00
HW957-S	Schalge Cloverleaf Cam	\$5.00
HW957-A	Arrow Cloverleaf Cam	\$5.00
HW957-R	Sargent Cloverleaf Cam	\$5.00
HW1141	Schlage IC Cloverleaf Cam	\$5.00
HW904DBR	Right hand deadbolt lock body	\$171.00
HW903DBL	Left hand deadbolt lock body	\$171.00
HW870CRL	Left Hand Classroom lock body	\$171.00
HW875CRR	Right hand Classroom lock body	\$171.00
S6065	Replacement Battery Pack	\$38.00
S6174	Serviceable Replacement Battery Pack	\$48.00



Price Book 2019

ALARM LOCK TRILOGY T2 SERIES EXIT TRIM

Battery operated Trilogy T2 keyless access outside trim works with Marks M9900, Von Duprin 99, Corbin ED5000, Yale 7100, Dorma 9300, Arrow 3800, Sargent 8800, Precision 1100, 2100 & Cal Royal 9800, Hager 4500 series panic devices. Holds up 100 user codes, 1 master, 10 manager codes and up to 3 one time user codes.

SPECIFICATIONS:

Door Thickness:	Standard model fits 1 5/8" to 1 7/8"
Handing:	Non-handed
Power:	5 AA alkaline batteries (included) mounted on the inside of door
Keypad:	Weather-resistant all metal, 12 button. All functions programmed through keypad.
Cylinder:	Use standard rim cylinder to operate key override function. Will accept 6 or 7 pin interchangeable core cylinders (see below).



Crash bar not included

ALL ET SERIES LOCKS ARE WEATHER-RESISTANT PLEASE CHECK WITH FACTORY FOR LEAD TIMES ON SPECIAL FINISHES

PRODUCT	DESCRIPTION	LIST PRICE
ETDL27 series	26D	\$920.00
ETDL27 series	US3 & US10B	\$990.00
ETDL27 series w/Regal lever	26D	\$946.00
ETDL27 series w/Regal lever	US3 & US10B	\$1,017.00
Specify finish on adapter kit		
ET- AL Finish = 26D, US3 & US10B	Alarm Lock Standard Rim Cylinder Adapter kit (Schlage C keyway)	\$57.00
ET- AR Finish = 26D, US3 & US10B	Arrow Standard Rim Cylinder Adapter kit	\$57.00
ET- AS Finish = 26D, US3 & US10B	ASSA Standard Rim Cylinder Adapter kit	\$57.00
ET - C Finish = 26D, US3 & US10B	Corbin Standard Rim Cylinder Adapter kit	\$57.00
ET - M Finish = 26D, US3 & US10B	Medeco Standard Rim Cylinder Adapter kit	\$57.00
ET - R Finish = 26D, US3 & US10B	Sargent Standard Rim Cylinder Adapter kit	\$57.00
ET - S Finish = 26D, US3 & US10B	Schlage Standard Rim Cylinder Adapter kit	\$57.00
ET - Y Finish = 26D, US3 & US10B	Yale Standard Rim Cylinder Adapter kit	\$57.00
ET - ARIC Finish = 26, 26D, 3, 4, 5, 10B	Arrow IC 6 & 7 Pin Rim Cylinder Adapter kit	\$79.00
ET - BIC Finish = 26D, US3 & US10B	Best IC 6 & 7 Pin Rim Cylinder Adapter kit	\$79.00
ET - CIC Finish = 26D, US3 & US10B	Corbin IC Rim Cylinder Adapter kit	\$79.00
ET - MIC Finish = 26D, US3 & US10B	Medeco IC 6 & 7 Pin Rim Cylinder Adapter kit	\$79.00



Price Book 2019

NEW! ALARM LOCK TRILOGY T2 SERIES EXIT TRIM (con't)

Product	Description	List Price
ET - RIC Finish = 26D, US3 & US10B	Sargent IC Rim Cylinder Adapter kit	\$79.00
ET - SIC Finish = 26D, US3 & US10B	Schlage IC Rim Cylinder Adapter kit	\$79.00
ET - YIC Finish = 26D, US3 & US10B	Yale IC 6 Pin Rim Cylinder Adapter kit	\$79.00

EXTENDED SPINDLES MUST BE PURCHASED SEPARATELY

S6146 Extended Spindle and screws	Extend exit trim to fit 2 – 2 ¼” doors	\$112.00
S6147 Extended Spindle and screws	Extend exit trim to fit 3 – 4” doors	\$112.00
S6195 Extended Spindle and screws	Extend exit trim to fit 4 ¼ - 5” doors	\$112.00
SC544	Extended replacement screws with adjustable lengths (4 per unit)	\$21.00 each

PLEASE SEE “HOW TO ORDER” CHART ON NEXT PAGE TO PROPERLY ORDER YOUR TRILOGY EXIT TRIM.

IF YOU REQUIRE THE LOCK TO BE PREPPED FOR A THICKER DOOR, YOU MUST ORDER BASED ON THE SELECTIONS SHOWN. THE BASIC MODEL IS PREPPED FOR A 1 5/8” TO 1 7/8” DOOR.

****** PRECISION 2100 SERIES WILL WORK WITH THE VON DUPRIN 99 PREP. YOU MUST GET A MOUNTING PLATE PART # BP21 FROM PRECISION******

Price Book 2019

HOW TO ORDER YOUR T2 TRILOGY EXIT LOCK

Below is a “How to Order” guide for the Trilogy Exit Trim products. Please follow this guide when placing orders to avoid any delay in processing your order.

All units are sold with a generic cylinder adapter installed. When you are using a specific brand of rim cylinder, you must purchase a Cylinder Adapter Kit from the chart below.

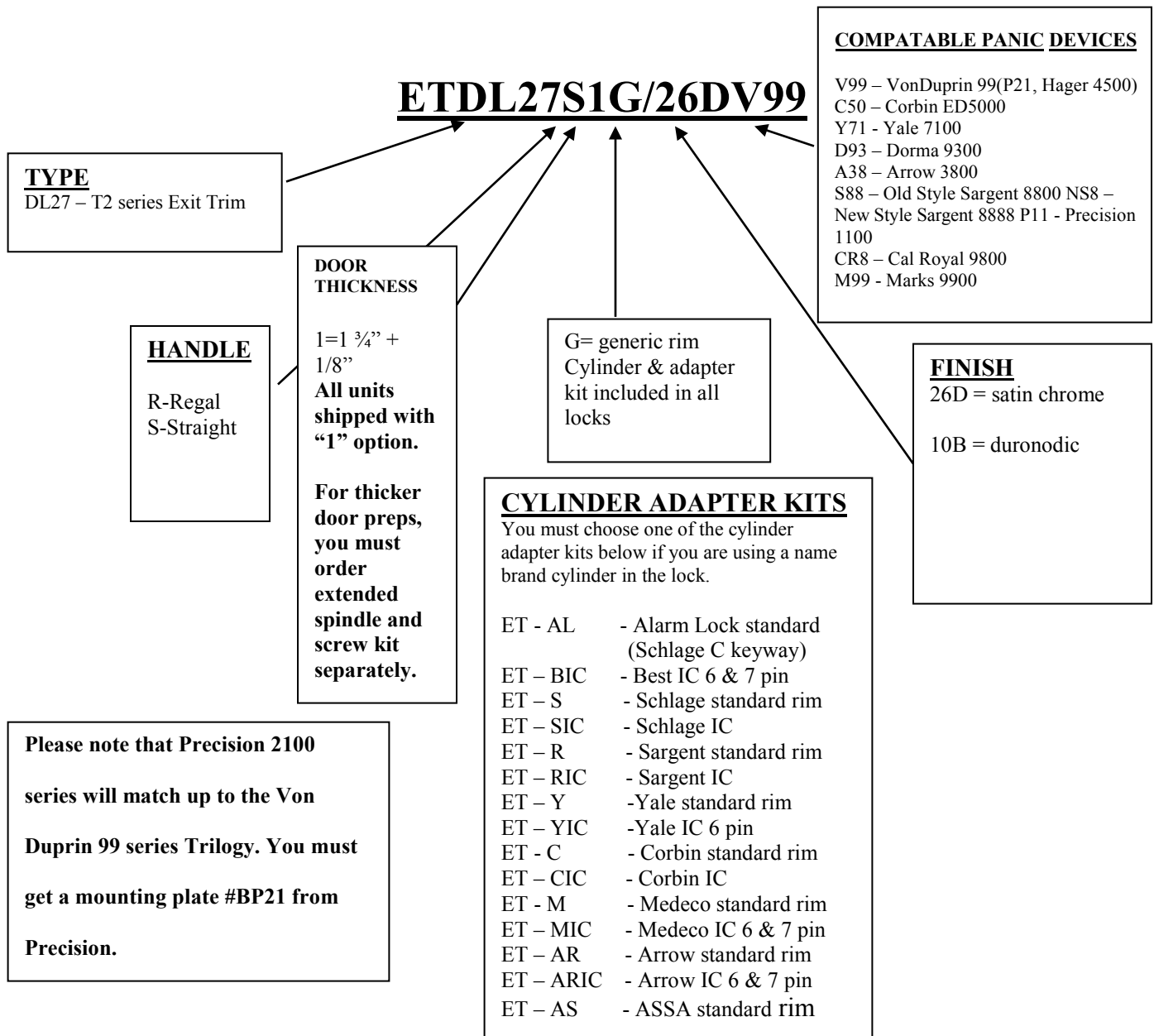



TRILOGY ELECTRONIC DIGITAL LOCKS

DL2800 SERIES – Electronic battery operated digital lock. Holds up to 200 codes, Master, Management, Supervisor & basic user. 150 event schedule, real time clock & 1,000 event audit trail.

SPECIFICATIONS:



Door Thickness:	Fits 1 5/8" to 1 7/8". Other thickness, refer to chart to the right.
Backset:	2 3/4" (2 3/8" also available. Must specify when ordering)
Strike:	1 1/8" x 2 3/4" T strike & 1 1/4" x 4 7/8" ASA strike included
Latch bolt:	UL Listed, fire rated 3 hours, 1/2" throw, reversible
Handing:	Non-handed
Power:	5 AA alkaline batteries (included)
Keypad:	All metal, 12 button. All functions programmed through keypad
Door Prep:	Standard ANSI A115 Series prep, modified by adding additional through-bolt holes
Compliances:	BHMA Certified Grade 1 heavy duty cylindrical lockset UL Listed 10C Positive Pressure Specification. FCC Certified ADA compliant levers
Cylinder:	6 pin solid brass. SCY1 keyway furnished with all key override locks Schlage, Corbin-Russwin CL, Sargent 480 series, ASSA 65-611 & Lori cylinders can be used with the HW620 tailpiece (supplied)
Interchangeable Core Models:	Standard model accepts 6 & 7 pin cylinders from Best, Falcon, Arrow, KSP, Medeco Keymark & Kaba Peaks. IC core models prepped for 6 & 7 pin Yale and Corbin-Russwin IC core models prepped for 6 pin Medeco, Sargent, and Schalg

Extended sizes:
Standard and SFIC cylinder
preps can be extended for
thicker doors.

**\$165.00 add on to list for
extended lock.**

Extended lock legend:
W54 - 2 1/8"
W57 - 2 1/4"
W60 - 2 3/8"
W64 - 2 1/2"
W70 - 2 3/4"
W76 - 3"
W83 - 3 1/4"
W89 - 3 1/2"

Note: Locks can be adjusted
by +/- 1/8" by adding or
removing spacers.

**All DL2800 LOCKS ARE WEATHER-RESISTANT
PLEASE CHECK WITH FACTORY FOR LEAD TIMES
ON SPECIAL FINISHES AND IC PREPS**

PRODUCT	FINISH	LIST PRICE
DL2800	US26D	\$1,078.00
Standard key override	US3 & US10B	\$1,171.00
DL2875	US26D	\$1,102.00
Standard key override	US3 & US10B	\$1,188.00
Regal (curved) lever		
DL2800IC*	US26D	\$1,102.00
Interchangeable core	US3 & US10B	\$1,188.00
DL2875IC*	US26D	\$1,124.00
Interchangeable core	US3 & US10B	\$1,206.00
Regal (curved) lever		
DL2800SK	Mounted DL2800 demo	Call Factory
AL-DTMIII	Data Transfer Module	\$448.00
AL-PCI2	Computer interface cable for Serial connection includes DL-Windows Software	\$129.00
ALPCI2-U	USB computer interface cable includes DL-Windows software	\$237.00
MX1130	USB Converter	\$118.00
AL-IR1	Infrared Printer	\$520.00

*Add "C" for Corbin, "M" for Medeco, "R" for Sargent, "Y" for Yale and "S" for Schlage to end of the part number for specially prepped IC core models. Add \$15.00 to the list price shown above. **MUST SPECIFY 7 PIN FOR CORBIN AND YALE** For small format Medeco IC, specify SFIC prep.

TRILOGY ELECTRONIC DIGITAL LOCKS

DL3000 SERIES – Electronic battery operated digital lock. Holds up to 300 codes, Master, Management, Supervisor & basic user. 150 event schedule, real time clock & 1,600 event audit trail.

SPECIFICATIONS:

Door Thickness:	Fits 1 5/8" to 1 7/8". Other thickness, refer to chart to the right.
Backset:	2 3/4" (2 3/8" also available. Must specify when ordering)
Strike:	1 1/8" x 2 3/4" T strike & 1 1/4" x 4 7/8" ASA strike included
Latch bolt:	UL Listed, fire rated 3 hours, 1/2" throw, reversible
Handing:	Non-handed
Power:	5 AA alkaline batteries (included)
Keypad:	All metal, 12 button. All functions programmed through keypad
Door Prep:	Standard ANSI A115 Series prep, modified by adding additional through-bolt holes
Compliances:	BHMA Certified Grade 1 heavy duty cylindrical lockset UL Listed 10C Positive Pressure Specification. FCC Certified ADA compliant levers
Cylinder:	6 pin solid brass. SCY1 keyway furnished with all key override locks Schlage, Corbin-Russwin CL, Sargent 480 series, ASSA 65-611 & Lori cylinders can be used with the HW620 tailpiece (supplied)
Interchangeable Core Models:	Standard model accepts 6 & 7 pin cylinders from Best, Falcon, Arrow, KSP, Medeco Keymark & Kaba Peaks. IC core models prepped for 6 & 7 pin Yale and Corbin-Russwin IC core models prepped for 6 pin Medeco, Sargent, and Schlage

Extended sizes:
WP standard and SFIC cylinder preps can be extended for thicker doors.

\$165.00 add on to list for extended lock.

Extended lock legend:
W54 - 2 1/8"
W57 - 2 1/4"
W60 - 2 3/8"
W64 - 2 1/2"
W70 - 2 3/4"
W76 - 3"
W83 - 3 1/4"
W89 - 3 1/2"

Note: Locks can be adjusted by +/- 1/8" by adding or removing spacers.

**PLEASE CHECK WITH FACTORY FOR LEAD TIMES ON SPECIAL FINISHES AND IC PREPS
SPECIFY "WP" FOR WEATHER-RESISTANT MODEL**

PRODUCT	FINISH	LIST PRICE
DL3000	US26D	\$1,309.00
Standard key override	US3 & US10B	\$1,400.00
DL3075	US26D	\$1,303.00
Standard key override	US3 & US10B	\$1,378.00
Regal (curved) lever		
DL3000IC*	US26D	\$1,303.00
Interchangeable core	US3 & US10B	\$1,378.00
DL3075IC*	US26D	\$1,328.00
Interchangeable core	US3 & US10B	\$1,400.00
Regal (curved) lever		
DL3000WP	US26D	\$1,337.00
Weather proof key override	US3 & US10B	\$1,405.00
DL3075WP	US26D	\$1,360.00
Weather proof key override	US3 & US10B	\$1,405.00
Regal (curved) lever		
DL3000WPIC*	US26D	\$1,360.00
Weather proof interchangeable core	US3 & US10B	\$1,428.00
DL3075WPIC*	US26D	\$1,366.00
Weather proof interchangeable core	US3 & US10B	\$1,404.00
Regal (curved) lever		
DL3000SK	Mounted DL3000 demo	Call Factory
AL-DTMIII	Data Transfer Module	\$448.00
AL-PCI2	Computer interface cable for serial connection with DL-Windows Software	\$129.00
ALPCI2-U	USB computer interface cable includes DL-Windows software	\$237.00
MX1130	USB Converter	\$118.00
AL-IR1	Infra red Printer	\$520.00

*Add "C" for Corbin, "M" for Medeco, "R" for Sargent, "Y" for Yale and "S" for Schlage to end of the part number for specially prepped IC core models. Add \$15.00 to the list price shown above. **MUST SPECIFY 7 PIN FOR CORBIN AND YALE** For small format Medeco IC, specify SFIC prep.

TRILOGY ELECTRONIC DIGITAL LOCKS

DL3200 SERIES – Electronic battery operated digital lock. Holds up to 2,000 codes, Master, Management, Supervisor & basic user. 500 event schedule, multiple “one-time” user codes & 40,000 event audit trail.

SPECIFICATIONS:

Door Thickness:	Fits 1 5/8" to 1 7/8". Other thickness, refer to chart to the right.
Backset:	2 3/4" (2 3/8" also available. Must specify when ordering)
Strike:	1 1/8" x 2 3/4" T strike & 1 1/4" x 4 7/8" ASA strike included
Latch bolt:	UL Listed, fire rated 3 hours, 1/2" throw, reversible
Handing:	Non-handed
Power:	5 AA alkaline batteries (included)
Keypad:	All metal, 12 button. All functions programmed through keypad
Door Prep:	Standard ANSI A115 Series prep, modified by adding additional through-bolt holes
Compliances:	BHMA Certified Grade 1 heavy duty cylindrical lockset UL Listed 10C Positive Pressure Specification. FCC Certified ADA compliant levers
Cylinder:	6 pin solid brass. SCY1 keyway furnished with all key override locks Schlage, Corbin-Russwin CL, Sargent 480 series, ASSA 65-611 & Lori cylinders can be used with the HW620 tailpiece (supplied)
Interchangeable Core Models:	Standard model accepts 6 & 7 pin cylinders from Best, Falcon, Arrow, KSP, Medeco Keymark & Kaba Peaks. IC core models prepped for 6 & 7 pin Yale and Corbin-Russwin IC core models prepped for 6 pin Medeco, Sargent, and Schalge

Extended sizes:
Standard and SFIC cylinder preps can be extended for thicker doors.

\$165.00 add on to list for extended lock.

Extended lock legend:

W54 - 2 1/8"
W57 - 2 1/4"
W60 - 2 3/8"
W64 - 2 1/2"
W70 - 2 3/4"
W76 - 3"
W83 - 3 1/4"
W89 - 3 1/2"

Note: Locks can be adjusted by +/- 1/8" by adding or removing spacers.

**ALL DL3200 LOCKS ARE WEATHER-RESISTANT
PLEASE CHECK WITH FACTORY FOR LEAD TIMES ON SPECIAL
FINISHES AND IC PREPS**

PRODUCT	FINISH	LIST PRICE
DL3200	US26D	\$1,342.00
Standard key override	US3 & US10B	\$1,423.00
DL3275	US26D	\$1,371.00
Standard key override Regal (curved) lever	US3 & US10B	\$1,446.00
DL3200IC*	US26D	\$1,351.00
Interchangeable core	US3 & US10B	\$1,446.00
DL3275IC*	US26D	\$1,388.00
Interchangeable core Regal (curved) lever	US3 & US10B	\$1,457.00
DL3200SK	Mounted DL3200 demo	Call Factory
AL-DTMIII	Data Transfer Module	\$448.00
AL-PCI2	Computer interface cable for serial connection with DL-Windows Software	\$129.00
ALPCI2-U	USB computer interface cable includes DL-Windows software	\$237.00
MX1130	USB Converter	\$118.00
AL-IR1	Infrared Printer	\$520.00

***Add "C" for Corbin, "M" for Medeco, "R" for Sargent, "Y" for Yale and "S" for Schlage to end of the part number for specially prepped IC core models. Add \$15.00 to the list price shown above. **MUST SPECIFY 7 PIN FOR CORBIN AND YALE** For small format Medeco IC, specify SFIC prep.**

TRILOGY ELECTRONIC DOUBLE SIDED DIGITAL LOCKS

DL5300 SERIES- Double sided electronic battery operated digital lock. Holds up to 2,000 codes, Master, Management, Supervisor and basic user. 500 event schedule, multiple “one-time” user codes & 40,000 event audit trail. Programmable keypad on both sides of the door. Only primary keypad has data transfer capability. Key override is only operable on the primary side. The key on the secondary side is used only to remove the lever and access the batteries.

SPECIFICATIONS:

Door Thickness:	Fits 1 5/8" to 1 7/8".
Backset:	2 3/4" (2 3/8" also available. Must specify when ordering)
Strike:	1 1/8" x 2 3/4" T strike & 1 1/4" x 4 7/8" ASA strike included
Latch bolt:	UL Listed, fire rated 3 hours, 1/2" throw, reversible
Handing:	Non-handed
Power:	4 AA alkaline batteries (included)
Keypad:	All metal, 12 button. Basic functions programmed through keypad
Door Prep:	Standard ANSI A115 Series prep, modified by adding additional through-bolt holes
Compliances:	BHMA Certified Grade 1 heavy duty cylindrical lockset UL Listed 10C Positive Pressure Specification. FCC Certified ADA compliant levers
Cylinder:	6 pin solid brass. SCY1 keyway furnished with all key override locks Schlage, Corbin-Russwin CL, Sargent 480 series, ASSA 65-611 & Lori cylinders can be used with the HW620 tailpiece (supplied)
Interchangeable Core Models:	Standard model accepts 6 & 7 pin cylinders from Best, Falcon, Arrow only



ALL DL5300 LOCKS ARE WEATHER-RESISTANT PLEASE CHECK WITH FACTORY FOR LEAD TIMES ON SPECIAL FINISHES

PRODUCT	FINISH	LIST PRICE
DL5300	US26D	\$1,869.00
Standard key override	US3 & US10B	\$1,918.00
DL5375		
Standard key override	US26D	\$1,884.00
Regal (curved) lever	US3 & US10B	\$1,952.00
DL5300IC	US26D	\$1,874.00
Interchangeable core	US3 & US10B	\$1,974.00
DL5375IC		
Interchangeable core	US26D	\$1,883.00
Regal (curved) lever	US3 & US10B	\$1,986.00
DL5300SK	Mounted DL5300 demo	Call Factory
AL-DTMIII	Data Transfer Module	\$448.00
AL-PCI2	Computer interface cable for serial connection with DL-Windows Software	\$129.00
ALPCI2-U	USB computer interface cable includes DL-Windows software	\$237.00
MX1130	USB Converter	\$118.00
AL-IR1	Infra red Printer	\$520.00

Note: Key override operates latch on primary side only. Key override on secondary side protects the battery pack.

**TRILOGY ELECTRONIC DIGITAL LOCKS
WITH PRIVACY & RESIDENCY FEATURES**

DL4100 SERIES - Electronic battery operated digital lock. Holds up to 2000 codes, Master, Management, Supervisor & basic user. Multiple "one-time" user codes. 500 event schedule, real time clock & 40,000 event audit trail. Privacy feature will lock out all users for programmed amount of time. Residency feature-allows exiting without having to lock the door.

SPECIFICATIONS:



Flashing LED inside and outside indicates the room is occupied or locked

Door Thickness: Fits 1 5/8" to 1 7/8". Other thickness, refer to chart to the right.
Backset: 2 3/4" (2 3/8" also available. Must specify when ordering)
Strike: 1 1/8" x 2 3/4" T strike & 1 1/4" x 4 7/8" ASA strike included
Latch bolt: UL Listed, fire rated 3 hours, 1/2" throw, reversible
Handing: Non-handed
Power: 5 AA alkaline batteries (included)
Keypad: All metal, 12 button. All functions programmed through keypad
Door Prep: Standard ANSI A115 Series prep, modified by adding additional through-bolt holes
Compliances: BHMA Certified Grade 1 heavy duty cylindrical lockset
 UL Listed 10C Positive Pressure Specification. FCC Certified
 ADA compliant levers
Cylinder: 6 pin solid brass. SCY1 keyway furnished with all key override locks
 Schlage, Corbin-Russwin CL, Sargent 480 series, ASSA 65-611 & Lori cylinders can be used with the HW620 tailpiece (supplied)
Interchangeable Core Models: Standard model accepts 6 & 7 pin cylinders from Best, Falcon, Arrow, KSP, Medeco Keymark & Kaba Peaks.
 IC core models prepped for 6 & 7 pin Yale and Corbin-Russwin
 IC core models prepped for 6 pin Medeco, Sargent, and Schlage

Extended sizes:
 Standard and SFIC cylinder preps can be extended for thicker doors.
\$165.00 add on to list for extended lock.
 Extended lock legend:
 W54 - 2 1/8"
 W57 - 2 1/4"
 W60 - 2 3/8"
 W64 - 2 1/2"
 W70 - 2 3/4"
 W76 - 3"
 W83 - 3 1/4"
 W89 - 3 1/2"
 Note: Locks can be adjusted by +/- 1/8" by adding or removing spacers.

ALL DL4100 LOCKS ARE WEATHER RESISTANT PLEASE CHECK WITH FACTORY FOR LEAD TIMES ON SPECIAL FINISHES AND IC PREPS

PRODUCT	FINISH	LIST PRICE
DL4100	US26D	\$1,026.00
Standard key override	US3 & US10B	\$1,096.00
DL4175	US26D	\$1,050.00
Standard key override w/Regal (curved) lever	US3 & US10B	\$1,119.00
DL4100IC*	US26D	\$1,050.00
Interchangeable core prepped for Best®	US3 & US10B	\$1,119.00
DL4175IC*	US26D	\$1,067.00
Interchangeable core prepped for Best® W/Regal (curved) lever	US3 & US10B	\$1,142.00
DL4100SK	Mounted DL4100 Demo	Call Factory
AL-PCI2	Computer interface cable for serial connection includes DL-Windows software	\$129.00
ALPCI2-U	USB computer interface cable includes DL-Windows software	\$237.00
MX1130	USB Converter	\$118.00
AL-IR1	Infra-red Printer	\$520.00
AL-DTMIII	Data Transfer Module	\$448.00

*Add "C" for Corbin, "M" for Medeco, "R" for Sargent, "Y" for Yale and "S" for Schlage to end of the part number for specially prepped IC core models. Add \$15.00 to the list price shown above. **MUST SPECIFY 7 PIN FOR CORBIN AND YALE** For small format Medeco IC, specify SFIC prep.



ALARM LOCK

Price Book 2019

TRILOGY ELECTRONIC DIGITAL PROXIMITY LOCKS

PDL3000 SERIES - Electronic battery operated digital proximity lock. Holds up to 2000 codes, Master, Management, Supervisor & basic user. Multiple "one-time" user codes. 500 event schedule, real time clock & 40,000 event audit trail. Will read most HID card and keyfob formats.

SPECIFICATIONS:



Door Thickness: Fits 1 5/8" to 1 7/8". Other thickness, refer to chart to the right.
Backset: 2 3/4" (2 3/8" also available. Must specify when ordering)
Strike: 1 1/8" x 2 3/4" T strike & 1 1/4" x 4 7/8" ASA strike included
Latch bolt: UL Listed, fire rated 3 hours, 1/2" throw, reversible
Handing: Non-handed
Power: 5 AA alkaline batteries (included)
Keypad: All metal, 12 button. All functions programmed through keypad
Door Prep: Standard ANSI A115 Series prep, modified by adding additional through-bolt holes
Compliances: BHMA Certified Grade 1 heavy duty cylindrical lockset
 UL Listed 10C Positive Pressure Specification. FCC Certified
 ADA compliant levers
Cylinder: 6 pin solid brass. SCY1 keyway furnished with all key override locks
 Schlage, Corbin-Russwin CL, Sargent 480 series, ASSA 65-611 & Lori cylinders can be used with the HW620 tailpiece (supplied)
Interchangeable Core Models: Standard model accepts 6 & 7 pin cylinders from Best, Falcon, Arrow, KSP, Medeco Keymark & Kaba Peaks.
 IC core models prepped for 6 & 7 pin Yale and Corbin-Russwin
 IC core models prepped for 6 pin Medeco, Sargent, and Schalge

Extended sizes:
 Standard and SFIC cylinder preps can be extended for thicker doors.

\$165.00 add on to list for extended lock.

Extended lock legend:

- W54 - 2 1/8"
- W57 - 2 1/4"
- W60 - 2 3/8"
- W64 - 2 1/2"
- W70 - 2 3/4"
- W76 - 3"
- W83 - 3 1/4"
- W89 - 3 1/2"

Note: Locks can be adjusted by +/- 1/8" by adding or removing spacers.

ALL PDL3000 LOCKS ARE WEATHER RESISTANT PLEASE CHECK WITH FACTORY FOR LEAD TIMES ON SPECIAL FINISHES AND IC PREPS

PRODUCT	FINISH	LIST PRICE
PDL3000K	US26D	\$1,861.00
Key override audit trail	US10B	\$1,927.00
PDL3000	US26D	\$1,836.00
Standard key override	US3 & US10B	\$1,916.00
PDL3075	US26D	\$1,866.00
Standard key override	US3 & US10B	\$1,939.00
Regal (curved) lever		
PDL3000IC*	US26D	\$1,866.00
Interchangeable core	US3 & US10B	\$1,939.00
PDL3075IC*	US26D	\$1,886.00
Interchangeable core	US3 & US10B	\$1,939.00
Regal (curved) lever		
PDL3000SKLE	Mounted PDL3000 demo	Call Factory
AL-PCI2	Computer interface cable for serial Connection includes DL-Windows Software	\$129.00
ALPCI2-U	USB computer interface cable includes DL-Windows software	\$237.00
MX1130	USB Converter	\$118.00
AL-IR1	Infra-red Printer	\$520.00
AL-DTMIII	Data Transfer Module	\$448.00
AL-PRE2	Prox Card Enroller - HID and iClass	\$590.00
ALID1326	Proximity Access Cards 100 Per Box	\$505.00
ALHID1336	Proximity, Magnetic Stripe and Photo ID cards 100 per box	\$1,030.00
ALHID1386	Proximity and Photo ID Card 100 per box	\$927.00
ALHID1391	MicroProx Tag 10 per box	\$ 80.00
ALHID1346	Proximity keyfob 10 per box	\$118.00

*Add "C" for Corbin, "M" for Medeco, "R" for Sargent, "Y" for Yale and "S" for Schlage to end of the part number for specially prepped IC core models. Add \$15.00 to the list price shown above. **MUST SPECIFY 7 PIN FOR CORBIN AND YALE** For small format Medeco IC, specify SFIC prep.



Price Book 2019

TRILOGY ELECTRONIC DOUBLE SIDED DIGITAL PROXIMITY LOCKS

PDL5300 - Double sided electronic battery operated digital proximity lock. Holds up to 2000 codes, Master, Management, Supervisor and basic user. Multiple "one-time" user codes. 500 event schedule, 40,000 event audit trail. Programmable keypad on both sides of the door. Only primary keypad has data transfer capability Will read most HID card and keyfob formats. Key override is only operable on the primary side. The key on the secondary side is use only to remove the lever and access the batteries.

SPECIFICATIONS:

Door Thickness:	Fits 1 5/8" to 1 7/8".
Backset:	2 3/4" (2 3/8" also available. Must specify when ordering)
Strike:	1 1/8" x 2 3/4" T strike & 1 1/4" x 4 7/8" ASA strike included
Latch bolt:	UL Listed, fire rated 3 hours, 1/2" throw, reversible
Handing:	Non-handed
Power:	4 AA alkaline batteries (included)
Keypad:	All metal, 12 button. Basic functions programmed through keypad
Door Prep:	Standard ANSI A115 Series prep, modified by adding additional through-bolt holes
Compliances:	BHMA Certified Grade 1 heavy duty cylindrical lockset UL Listed 10C Positive Pressure Specification. FCC Certified ADA compliant levers
Cylinder:	6 pin solid brass. SCY1 keyway furnished with all key override locks Schlage, Corbin-Russwin CL, Sargent 480 series, ASSA 65-611 & Lori cylinders can be used with the HW620 tailpiece (supplied)
Interchangeable Core Models:	Standard model accepts 6 & 7 pin cylinders from Best, Falcon, Arrow only



ALL PDL5300 LOCKS ARE WEATHER-RESISTANT PLEASE CHECK WITH FACTORY FOR LEAD TIMES ON SPECIAL FINISHES

PRODUCT	FINISH	LIST PRICE
PDL5300	US26D	\$2,228.00
Standard key override	US3 & US10B	\$2,295.00
PDL5375	US26D	\$2,251.00
Standard key override	US3 & US10B	\$2,324.00
PDL5300IC	US26D	\$2,245.00
Interchangeable core	US3 & US10B	\$2,287.00
PDL5375IC	US26D	\$2,273.00
Interchangeable core	US3 & US10B	\$2,314.00
PDL5300SK	Mounted PDL3000 demo	Call Factory
AL-PCI2	Computer interface cable for serial Connection includes DL-Windows	\$129.00
ALPCI2-U	USB computer interface cable includes DL-Windows software	\$237.00
MX1130	USB Converter	\$118.00
AL-IR1	Infra-red Printer	\$520.00
AL-DTMIII	Data Transfer Module	\$448.00
AL-PRE2	Prox Card Enroller - HID and iClass	\$590.00
ALID1326	Proximity Access Cards 100 Per Box	\$505.00
ALHID1336	Proximity, Magnetic Stripe and Photo ID cards 100 per box	\$1,030.00
ALHID1386	Proximity and Photo ID Card 100 per box	\$927.00
ALHID1391	MicroProx Tag 10 per box	\$82.00
ALHID1346	Proximity keyfob 10 per box	\$118.00

Note: Key override operates latch on primary side only. Key override on secondary side protects the battery pack.

Price Book 2019

TRILOGY ELECTRONIC DIGITAL PROXIMITY LOCKS

PL3000 SERIES - Electronic battery operated proximity only lock. Holds up to 2000 users, Master, Management, Supervisor & basic user. Multiple "one-time" user codes. 500 event schedule, real time clock & 40,000 event audit trail. Will read most HID card and keyfob formats.

SPECIFICATIONS:



Door Thickness: Fits 1 5/8" to 1 7/8". Other thickness, refer to chart to the right.
Backset: 2 3/4" (2 3/8" also available. Must specify when ordering)
Strike: 1 1/8" x 2 3/4" T strike & 1 1/4" x 4 7/8" ASA strike included
Latch bolt: UL Listed, fire rated 3 hours, 1/2" throw, reversible
Handing: Non-handed
Power: 5 AA alkaline batteries (included)
Door Prep: Standard ANSI A115 Series prep, modified by adding additional through-bolt holes
Compliances: BHMA Certified Grade 1 heavy duty cylindrical lockset
 UL Listed 10C Positive Pressure Specification. FCC Certified
 ADA compliant levers
Cylinder: 6 pin solid brass. SCY1 keyway furnished with all key override locks
 Schlage, Corbin-Russwin CL, Sargent 480 series, ASSA 65-611 & Lori cylinders can be used with the HW620 tailpiece (supplied)
Interchangeable Core Models: Standard model accepts 6 & 7 pin cylinders from Best, Falcon, Arrow, KSP, Medeco Keymark & Kaba Peaks.
 IC core models prepped for 6 & 7 pin Yale and Corbin-Russwin
 IC core models prepped for 6 pin Medeco, Sargent, and Schlage

Extended sizes:
 Standard and SFIC cylinder preps can be extended for thicker doors.

\$165.00 add on to list for extended lock.

Extended lock legend:
 W54 - 2 1/8"
 W57 - 2 1/4"
 W60 - 2 3/8"
 W64 - 2 1/2"
 W70 - 2 3/4"
 W76 - 3"
 W83 - 3 1/4"
 W89 - 3 1/2"

Note: Locks can be adjusted by +/- 1/8" by adding or removing spacers.

ALL PL3000 LOCKS ARE WEATHER-RESISTANT PLEASE CHECK WITH FACTORY FOR LEAD TIMES ON SPECIAL FINISHES

PRODUCT	FINISH	LIST PRICE
PL3000	US26D	\$1,836.00
Standard key override	US3 & US10B	\$1,916.00
PL3075	US26D	\$1,866.00
Standard key override	US3 & US10B	\$1,939.00
Regal (curved) lever		
PL3000IC*	US26D	\$1,866.00
Interchangeable core	US3 & US10B	\$1,939.00
PL3075IC*	US26D	\$1,886.00
Interchangeable core	US3 & US10B	\$1,939.00
Regal (curved) lever		
PL3000SK	Mounted PL3000 Demo	Call Factory
AL-PCI2	Computer interface cable for serial connection includes DL-Windows software	\$129.00
ALPCI2-U	USB computer interface cable includes DL-Windows software	\$237.00
MX1130	USB Converter	\$118.00
AL-IR1	Infra-red Printer	\$520.00
AL-DTMIII	Data Transfer Module	\$448.00
AL-PRE2	Prox Card Enroller - HID and iClass	\$590.00
ALID1326	Proximity Access Cards 100 Per Box	\$505.00
ALHID1336	Proximity, Magnetic Stripe and Photo ID cards 100 per box	\$1,030.00
ALHID1386	Proximity and Photo ID Card 100 per box	\$927.00
ALHID1391	MicroProx Tag 10 per box	\$82.00
ALHID1346	Proximity keyfob 10 per box	\$118.00

*Add "C" for Corbin, "M" for Medeco, "R" for Sargent, "Y" for Yale and "S" for Schlage to end of the part number for specially prepped IC core models. Add \$15.00 to the list price shown above. **MUST SPECIFY 7 PIN FOR CORBIN AND YALE** For small format Medeco IC, specify SFIC prep.

TRILOGY ELECTRONIC DIGITAL PROXIMITY LOCKS WITH PRIVACY & RESIDENCY FEATURES

PDL4100 SERIES - Electronic battery operated digital proximity lock. Holds up to 2000 codes, Master, Management, Supervisor & basic user. Multiple "one-time" user codes. 500 event schedule, real time clock & 40,000 event audit trail. Will read most HID card and keyfob formats. Privacy feature will lock out all users for a programmed amount of time. Residency feature-allows exiting without having to lock the door.

SPECIFICATIONS:

Door Thickness: Fits 1 5/8" to 1 7/8". Other thickness, refer to chart to the right.
Backset: 2 3/4" (2 3/8" also available. Must specify when ordering)
Strike: 1 1/8" x 2 3/4" T strike & 1 1/4" x 4 7/8" ASA strike included
Latch bolt: UL Listed, fire rated 3 hours, 1/2" throw, reversible
Handing: Non-handed
Power: 5 AA alkaline batteries (included)
Keypad: All metal, 12 button. All functions programmed through keypad
Door Prep: Standard ANSI A115 Series prep, modified by adding additional through-bolt holes
Compliances: BHMA Certified Grade 1 heavy duty cylindrical lockset
 UL Listed 10C Positive Pressure Specification. FCC Certified ADA compliant levers
Cylinder: 6 pin solid brass. SCY1 keyway furnished with all key override locks
 Schlage, Corbin-Russwin CL, Sargent 480 series, ASSA 65-611 & Lori cylinders can be used with the HW620 tailpiece (supplied)
Interchangeable Core Models: Standard model accepts 6 & 7 pin cylinders from Best, Falcon, Arrow, KSP, Medeco Keymark & Kaba Peaks.
 IC core models prepped for 6 & 7 pin Yale and Corbin-Russwin
 IC core models prepped for 6 pin Medeco, Sargent, and Schlage

Extended sizes:
 Standard and SFIC cylinder preps can be extended for thicker doors.

\$165.00 add on to list for extended lock.

Extended lock legend:
 W54 - 2 1/8"
 W57 - 2 1/4"
 W60 - 2 3/8"
 W64 - 2 1/2"
 W70 - 2 3/4"
 W76 - 3"
 W83 - 3 1/4"
 W89 - 3 1/2"

Note: Locks can be adjusted by +/- 1/8" by adding or removing spacers.



Flashing LED inside and outside indicates the room is occupied or locked

**ALL PDL4100 LOCKS ARE WEATHER-RESISTANT
 PLEASE CHECK WITH FACTORY FOR LEAD TIMES
 ON SPECIAL FINISHES AND IC PREPS**

PRODUCT	FINISH	LIST PRICE
PDL4100	US26D	\$1,492.00
	US3 & US10B	\$1,578.00
PDL4175	US26D	\$1,508.00
	US3 & US10B	\$1,612.00
PDL4100IC*	US26D	\$1,508.00
	US3 & US10B	\$1,612.00
PDL4175IC*	US26D	\$1,543.00
	US3 & US10B	\$1,612.00
PDL4100SK	Mounted PDL4100 demo	Call Factory
AL-PCI2	Computer interface cable for serial connection Includes DL-Windows	\$129.00
ALPCI2-U	USB computer interface cable includes DL-Windows software	\$237.00
MX1130	USB Converter	\$118.00
AL-IR1	Infra-red Printer	\$520.00
AL-DTMIII	Data Transfer Module	\$448.00
AL-PRE2	Prox Card Enroller - HID and iClass	\$590.00
ALID1326	Proximity Access Cards 100 Per Box	\$505.00
ALHID1336	Proximity, Magnetic Stripe and Photo ID cards 100 per box	\$1,030.00
	Proximity and Photo ID Card 100 per box	\$927.00
ALHID1386	Proximity and Photo ID Card 100 per box	\$927.00
ALHID1391	MicroProx Tag 10 per box	\$82.00
ALHID1346	Proximity keyfob 10 per box	\$118.00

*Add "C" for Corbin, "M" for Medeco, "R" for Sargent, "Y" for Yale and "S" for Schlage to end of the part number for specially prepped IC core models. Add \$15.00 to the list price shown above. **MUST SPECIFY 7 PIN FOR CORBIN AND YALE** For small format Medeco IC, specify SFIC prep.



TRILOGY CYLINDRICAL LOCK PARTS

Part Number	Description	List Price
S6054	Complete Outside housing for DL2700WP available finishes 26D, 3, & 10B	\$376.00
S6126	Complete outside housing for DL2800 available finishes 26D, 3, & 10B	\$457.00
S6047	Complete outside housing for DL3000WP available finishes 26D, 3, & 10B	\$696.00
S6122	Complete outside housing for PDL3000 available finishes 26D, 3, & 10B	\$1,087.00
S6163	Complete outside housing for DL4100 available finishes 26D, 3, & 10B	\$524.00
S6164	Complete outside housing for PDL4100 available finishes 26D, 3, & 10B	\$893.00
S6045	Standard key override lock body complete	\$326.00
S6046	Best prep interchangeable core lock body complete	\$326.00
S6045-C/R	Corbin/Sargent prep interchangeable core lock body complete	\$358.00
S6045-Y/M	Yale/Medeco prep interchangeable core lock body complete	\$358.00
S6045-S	Schlage prep interchangeable core lock body complete	\$358.00
HW614C	Outside lever standard prep available finishes 26D, 3, & 10B	\$37.00
HW616C	Outside lever Best IC prep available finishes 26D, 3, & 10B	\$37.00
HW615D	Inside lever for all cylindrical locks available finishes 26D, 3, & 10B	\$37.00
HW592G	Battery Cover available finishes 26D, 3, & 10B	\$21.00
P5849	Latch bolt 2 3/4" available finishes 26D, 3, & 10B	\$26.00
S5980-1	Latch bolt 2 3/8" 26D finish	\$26.00
S5980-2	Latch bolt 2 3/8" US5 finish	\$26.00
HW470	4 7/8" strike available 26D, 3, & 10B	\$15.00
HW577	2 3/4" strike available finishes 26D, 3, & 10B	\$16.00
HW596F	Standard cylinder w/2 keys available finishes 26D, 3, & 10B	\$26.00
S6148	Lever return spring	\$5.00
S6061	Replacement battery pack cylindrical	\$47.00
S6172	Replacement battery pack Double sided	\$30.00
HW580	Schlage® key override tailpiece for Cylindrical locks	\$11.00
HW620D	Lori® key override tailpiece for Cylindrical locks	\$11.00
HW597E	Alarm Lock cylindrical key override tailpiece	\$11.00
HW598E	Cylindrical Interchangeable core Tailpiece Best prep	\$11.00
S6070	IC tailpiece bag assembly w/washer Specify for the following: S – Schlage, B – Best, R – Sargent, M – Medeco, Y – Yale, C – Corbin	\$16.00
MX942	Replacement DTM cable	\$20.00



Price Book 2019

TRILOGY CYLINDRICAL LOCK PARTS (con't)

Part Number	Description	List Price
WA160C	Washer used on HW620, HW597C & HW598E	\$3.00
S6072	Set of spacers for doors 1 3/8" or less	\$70.00
CW-27AB	Wrap around plate in US5	\$65.00
CW-27PB	Wrap around plate in US3	\$70.00
CW-27S	Wrap around plate US32D	\$70.00
DL2700DJ	Drilling Jig for cylindrical locks	\$417.00

TRILOGY LOCK ACCESSORIES

AL-PCI2	Computer interface cable for serial Connection includes DL-Windows Software	\$129.00
ALPCI2-U	USB computer interface cable includes DL-Windows software	\$237.00
MX1130	USB Converter	\$118.00
AL-IR1	Infra-red Printer	\$520.00
AL-DTMIII	Data Transfer Module	\$448.00
AL-PRE2	Prox Card Enroller - HID and iClass	\$590.00
ALID1326	Proximity Access Cards 100 Per Box	\$505.00
ALHID1336	Proximity, Magnetic Stripe and Photo ID cards 100 per box	\$1,030.00
ALHID1386	Proximity and Photo ID Card 100 per box	\$927.00
ALHID1391	MicroProx Tag 10 per box	\$82.00
ALHID1346	Proximity keyfob 10 per box	\$118.00
ALTRAINDVD	Trilogy DL-Windows and Networx Connectivity software training videos divided into 4 easy to follow sections conducted into a classroom style environment. Training videos cover basics, getting started, schedules and times zones, programming Trilogy locks via a laptop and the DTM along with how to connect and bring Networx on line.	\$0.00 + \$15.95 shipping and handling charge. Please contact customer service at 1-800-ALA-LOCK to place your order via credit card, or email sales@alarmlock.com



Price Book 2019

TRILOGY & NETWORKX REMOTE RELEASE PRODUCTS



PRODUCT	DESCRIPTION	LIST PRICE
RR-TRILOGYKIT	Remote release kit for all Trilogy Cylindrical models includes the RR-1BUTTON for desk mount applications and RR-RECEIVER which is designed to be installed inside the battery compartment next to the battery pack of any cylindrical Trilogy lock. The RR-RECEIVER connects to the 2 white remote release wires inside the battery compartment and to the black and red battery pack wires to power the receiver. These kits will retro fit to any existing cylindrical Trilogy manufactured since 1994.	\$221.00
RR-RECEIVER	RR-RECEIVER is designed to be installed next to the battery pack of any cylindrical Trilogy lock. The RR-RECEIVER connects to the 2 white remote release wires and to the black and red battery pack wires and will retro fit to any existing cylindrical Trilogy manufactured since 1994. You will need to purchase separately either an RR-1BUTTON OR 4BKEYFOB to activate the receiver	\$128.00
RR-1BUTTON	Remote release desk mounted button designed to be used with any existing Networkx lock enrolled with a simple keypad program. Must update the firmware of your existing Networkx Lock. Also can be used with an RR-RECEIVER to any existing Trilogy Cylindrical Lock, RR-RECEIVER sold separately.	\$92.00
RR-4BKEYFOB	Remote release 4 button key fob designed to be used with any existing Networkx lock enrolled with a simple keypad program. Must update the firmware of your existing Networkx Lock. Also can be used with an RR-RECEIVER to any existing Trilogy Cylindrical Lock, RR-RECEIVER sold separately.	\$103.00
RR-MORTISEKIT	Remote release kit for Mortise Locks	\$242.00
RR-EXITTRIMKIT	Remote release kit for Exit Trim Locks *Both include RR-1BUTTON and RECEIVER mounted on a Lexan battery cover.*	\$242.00

Note: The Remote Release Products follow the Networkx Discount Structure. Will not work with non-Networkx Narrow Stile series lock sets.



TRILOGY ELECTRONIC DIGITAL MORTISE LOCKS

DL3500 SERIES - Electronic battery operated digital mortise lock. Holds up to 300 codes, Master, Management, Supervisor & basic user. 500 event schedule, real time clock & 40,000 event audit trail.

SPECIFICATIONS:

Door Thickness:	Fits 1 5/8" to 1 7/8"
Backset:	2 3/4" standard
Strike:	1 1/4" x 4 7/8" strike included
Handing:	Specify RH or LH when ordering. Lock is reversible in the field.
Power:	5 AA alkaline batteries (included)
Keypad:	All metal, 12 button. All functions programmed through keypad
Door Prep:	Standard ANSI A115 mortise prep, modified by adding additional through-bolt holes
Compliances:	Steelcase lock body meets BHMA specifications for Grade 1 locks UL Listed 10C Positive Pressure Specification. FCC Certified ADA compliant levers
Functions:	Classroom function features stainless steel latch bolt With 3/4" (1.91cm) projection and deadlocking latch. Deadbolt function features stainless steel deadbolt with 1" (2.55cm) projection, latch bolt with 3/4" (1.91cm) projection and deadlocking latch. Deadbolt may be projected from key cylinder from outside door or turn-piece from inside door.
Cylinder:	1 3/8" (3.5cm) mortise cylinder supplied. Will accept 1 3/8" to 1 1/2" (3.5 - 3.8cm) mortise cylinder.
Cams:	Classroom function supplied with straight cam. Deadbolt function supplied with cloverleaf cam. Cams for other manufacturer's cylinder are available. See 'Mortise Lock accessories' for part numbers & manufacturers.



**ALL DL3500 MORTISE LOCKS ARE WEATHER-RESISTANT
PLEASE CHECK WITH FACTORY ON LEAD TIMES FOR SPECIAL FINISHES**

PRODUCT	FINISH	LIST PRICE
DL3500CRR Straight lever classroom function Right hand	US26D US3 & US10B	\$1,516.00 \$1,590.00
DL3500CRL Straight lever classroom function Left Hand	US26D US3 & US10B	\$1,516.00 \$1,590.00
DL3500DBR Straight lever deadbolt function Right hand	US26D US3 & US10B	\$1,516.00 \$1,590.00
DL3500DBL Straight lever deadbolt function Left Hand	US26D US3 & US10B	\$1,516.00 \$1,590.00
DL3575CRR Regal (curved) lever classroom Function right hand	US26D US3 & US10B	\$1,532.00 \$1,606.00
DL3575CRL Regal (curved) lever classroom Function left hand	US26D US3 & US10B	\$1,532.00 \$1,606.00
DL3575DBR Regal (curved) lever deadbolt Function right hand	US26D US3 & US10B	\$1,532.00 \$1,606.00
DL3575DBL Regal (curved) lever deadbolt Function left hand	US26D US3 & US10B	\$1,532.00 \$1,606.00



TRILOGY ELECTRONIC DIGITAL MORTISE LOCKS (con't)

PRODUCT	DESCRIPTION	LIST PRICE
DL3500SK	Mounted sales kit, straight lever. Available in classroom or deadbolt function.	Call Factory
AL-DTMIII	Data Transfer Module	\$448.00
AL-PCI2	Computer interface cable for serial connection includes DL-Windows software	\$129.00
ALPCI2-U	USB computer interface cable includes DL-Windows software	\$237.00
MX1130	USB Converter	\$118.00
AL-IR1	Infra red Printer	\$520.00
ALTRAINDVD	Trilogy DL-Windows and Networx Connectivity software training videos divided into 4 easy to follow sections conducted into a classroom style environment. Training videos cover basics, getting started, schedules and times zones, programming Trilogy locks via a laptop and the DTM along with how to connect and bring Networx on line.	\$0.00 + \$15.95 shipping and handling charge. Please contact customer service at 1-800-ALA-LOCK to place your order via credit card, or email sales@alarmlock.com

MORTISE LOCK PARTS

CLASSROOM FUNCTION CAMS	DESCRIPTION	LIST PRICE
HW956-L	Alarm Lock Standard Straight Cam	\$5.00
HW956-M	Marks Straight Cam	\$5.00
HW956-C	Corbin-Russwin Straight Cam	\$5.00
HW956-S	Schlage Straight Cam	\$5.00
HW956-A	Arrow Straight Cam	\$5.00
HW956-R	Sargent Straight Cam	\$5.00
DEADBOLT FUNCTION CAMS		
HW957-L	Alarm Lock Standard Cloverleaf Cam	\$5.00
HW957-M	Marks Cloverleaf Cam	\$5.00
HW957-C	Corbin-Russwin Cloverleaf Cam	\$5.00
HW957-S	Schlage Cloverleaf Cam	\$5.00
HW957-A	Arrow Cloverleaf Cam	\$5.00
HW957-R	Sargent Cloverleaf Cam	\$5.00
HW1141	Schlage IC Cloverleaf Cam	\$5.00

S6123	DL3500 complete outside housing available in 26D, US3 & US10B	\$1,008.00
S6175	Replacement lever support spring	\$3.00
S6192	Lever and spring upgrade kit Standard lever – 26D, 10B, US3	\$54.00
S6193	Lever and spring upgrade kit Regal lever – 26D, 10B, US3	\$80.00
HW904DBR	Right hand deadbolt lock body	\$171.00
HW903DBL	Left hand deadbolt lock body	\$171.00
HW870CRL	Left Hand Classroom lock body	\$171.00
HW875CRR	Right hand Classroom lock body	\$171.00
S6065	Replacement Battery Pack	\$38.00
S6174	Serviceable Replacement Battery Pack	\$48.00



Price Book 2019

TRILOGY ELECTRONIC DIGITAL MORTISE LOCKS WITH PRIVACY & RESIDENCY FEATURES

DL4500 SERIES - Electronic battery operated digital proximity lock. Holds up to 2000 codes, Master, Management, Supervisor & basic user. 500 event schedule, real time clock & 40,000 event audit trail. Privacy feature will lock out all users for programmed amount of time. Residency feature-allows exiting without having to lock the door.

SPECIFICATIONS:

Door Thickness: Fits 1 5/8" to 1 7/8"
Backset: 2 3/4" standard
Strike: 1 1/4" x 4 7/8" strike included
Handing: Specify RH or LH when ordering. Lock is reversible in the field.
Power: 5 AA alkaline batteries (included)
Keypad: All metal, 12 button. All functions programmed through keypad
Door Prep: Standard ANSI A115 mortise prep, modified by adding additional through-bolt holes
Compliances: Steelcase lock body meets BHMA specifications for Grade 1 locks
 UL Listed 10C Positive Pressure Specification. FCC Certified
 ADA compliant levers
Functions: Deadbolt function only. Features stainless steel deadbolt with 1" (2.55cm) projection, latch bolt with 3/4" (1.91cm) projection and deadlocking latch. Deadbolt may be projected from key cylinder from outside door or turn-piece from inside door.
Cylinder: 1 3/8" (3.5cm) mortise cylinder supplied. Will accept 1 3/8" to 1 1/2" (3.5 - 3.8cm) mortise cylinder.
Cams: Supplied with cloverleaf cam. Cams for other manufacturer's cylinder are available. See 'Privacy Mortise Lock accessories' for part numbers and manufactures.



**ALL DL4500 LOCKS ARE WEATHER-RESISTANT
PLEASE CHECK WITH FACTORY FOR LEAD TIMES ON SPECIAL FINISHES**

PRODUCT	FINISH	LIST PRICE
DL4500DBR Straight lever deadbolt function Right hand	US26D US3 & US10B	\$1,142.00 \$1,216.00
DL4500DBL Straight lever deadbolt function Left Hand	US26D US3 & US10B	\$1,142.00 \$1,216.00
DL4575DBR Regal (curved) lever deadbolt Function right hand	US26D US3 & US10B	\$1,164.00 \$1,233.00
DL4575DBL Regal (curved) lever deadbolt Function left hand	US26D US3 & US10B	\$1,164.00 \$1,233.00
AL-PCI2	Computer interface cable for serial connection includes DL-Windows software	\$129.00
ALPCI2-U	Computer interface cable for serial and USB computer interface cable includes DL-Windows software	\$237.00
MX1130	USB Converter	\$118.00
AL-IR1	Infra-red Printer	\$520.00
AL-DTMIII	Data Transfer Module	\$448.00
DL4500SK	Mounted DL4500 Demo	Call Factory



Price Book 2019

TRILOGY ELECTRONIC PROXIMITY MORTISE LOCKS

PDL3500/PL3500 - Electronic battery operated digital mortise lock. Holds up to 2000 user codes, Master, Management, Supervisor & basic user. 500 scheduled events, real time clock & 40,000 event audit trail. Will read most HID card and keyfob formats.

SPECIFICATIONS:

Door Thickness:	Fits 1 5/8" to 1 7/8"
Backset:	2 3/4" standard
Strike:	1 1/4" x 4 7/8" strike included
Handing:	Specify RH or LH when ordering. Lock is reversible in the field.
Power:	5 AA alkaline batteries (included)
Keypad:	All metal, 12 button. All functions programmed through keypad
Door Prep:	Standard ANSI A115 mortise prep, modified by adding additional through-bolt holes
Compliances:	Steelcase lock body meets BHMA specifications for Grade 1 locks UL Listed 10C Positive Pressure Specification. FCC Certified ADA compliant levers
Functions:	Classroom function features stainless steel latch bolt With 3/4" (1.91cm) projection and deadlocking latch. Deadbolt function features stainless steel deadbolt with 1" (2.55cm) projection, latch bolt with 3/4" (1.91cm) projection and deadlocking latch. Deadbolt may be projected from key cylinder from outside door or turn-piece from inside door.
Cylinder:	1 3/8" (3.5cm) mortise cylinder supplied. Will accept 1 3/8" to 1 1/2" (3.5 - 3.8cm) mortise cylinder.
Cams:	Classroom function supplied with straight cam. Deadbolt function supplied with cloverleaf cam. Cams for other manufacturer's cylinder are available. See 'Mortise Lock accessories' for part numbers & manufacturers.



ALL PDL3500 LOCKS ARE WEATHER-RESISTANT
PLEASE CHECK WITH FACTORY FOR LEAD TIMES ON SPECIAL FINISHES

PRODUCT	FINISH	LIST PRICE
PDL3500CRR Straight lever classroom function Right hand	US26D US3 & US10B	\$1,940.00 \$2,020.00
PDL3500CRL Straight lever classroom function Left Hand	US26D US3 & US10B	\$1,940.00 \$2,020.00
PDL3500DBR Straight lever deadbolt function Right hand	US26D US3 & US10B	\$1,940.00 \$2,020.00
PDL3500DBL Straight lever deadbolt function Left Hand	US26D US3 & US10B	\$1,940.00 \$2,020.00
PDL3575CRR Regal (curved) lever classroom Function right hand	US26D US3 & US10B	\$1,956.00 \$2,037.00
PDL3575CRL Regal (curved) lever classroom Function left hand	US26D US3 & US10B	\$1,956.00 \$2,037.00



Price Book 2019

TRILOGY ELECTRONIC PROXIMITY MORTISE LOCKS (con't)
PLEASE CHECK WITH FACTORY FOR LEAD TIMES ON SPECIAL FINISHES

PRODUCT	DESCRIPTION	LIST PRICE
PDL3575DBR Regal (curved) lever deadbolt Function right hand	US26D US3 & US10B	\$1,956.00 \$2,037.00
PDL3575DBL Regal (curved) lever deadbolt Function left hand	US26D US3 & US10B	\$1,956.00 \$2,037.00
PDL3500SK/26D	Mounted sales kit, straight lever. Available in classroom or deadbolt function.	Call Factory
PL3500CRR Straight lever classroom function Right hand	US26D US3 & US10B	\$1,940.00 \$2,020.00
PL3500CRL Straight lever classroom function Left Hand	US26D US3 & US10B	\$1,940.00 \$2,020.00
PL3500DBR Straight lever deadbolt function Right hand	US26D US3 & US10B	\$1,940.00 \$2,020.00
PL3500DBL Straight lever deadbolt function Left Hand	US26D US3 & US10B	\$1,940.00 \$2,020.00
PL3575CRR Regal (curved) lever classroom Function right hand	US26D US3 & US10B	\$1,956.00 \$2,037.00
PL3575CRL Regal (curved) lever classroom Function left hand	US26D US3 & US10B	\$1,956.00 \$2,037.00
PL3575DBR Regal (curved) lever deadbolt Function right hand	US26D US3 & US10B	\$1,956.00 \$2,037.00
PL3575DBL Regal (curved) lever deadbolt Function left hand	US26D US3 & US10B	\$1,956.00 \$2,037.00
AL-PCI2	Computer interface cable for serial connection includes DL-Windows software	\$129.00
ALPCI2-U	USB computer interface cable includes DL-Windows software	\$237.00
MX1130	USB Converter	\$118.00
AL-IR1	Infra-red Printer	\$520.00
AL-DTMIII	Data Transfer Module	\$448.00
AL-PRE2	Prox Card Enroller- HID and iClass	\$590.00
ALID1326	Proximity Access Cards 100 Per Box	\$505.00
ALHID1336	Proximity, Magnetic Stripe and Photo ID cards 100 per box	\$1,030.00
ALHID1386	Proximity and Photo ID Card 100 per box	\$927.00
ALHID1391	MicroProx Tag 10 per box	\$82.00
ALHID1346	Proximity keyfob 10 per box	\$118.00
ALTRAINDVD	Trilogy DL-Windows and Network Connectivity software training videos divided into 4 easy to follow sections conducted into a classroom style environment. Training videos cover basics, getting started, schedules and times zones, programming Trilogy locks via a laptop and the DTM along with how to connect and bring Network on line.	\$0.00 + \$15.95 shipping and handling charge. Please contact customer service at 1-800-ALA-LOCK to place your order via credit card, or email sales@alarmlock.com
S6190	Exit Trim/Mortise Lock Parts Kit	\$151.00

TRILOGY ELECTRONIC DIGITAL PROXIMITY MORTISE LOCKS WITH PRIVACY & RESIDENCY FEATURES

PDL4500 - Electronic battery operated digital proximity lock. Holds up to 2000 codes, Master, Management, Supervisor & basic user. 500 event schedule, real time clock & 40,000 event audit trail. Will read most HID card and keyfob formats. Privacy feature will lock out all users for a programmed amount of time. Residency feature- allows exiting without having to lock the door.

SPECIFICATIONS:

Door Thickness:	Fits 1 5/8" to 1 7/8"
Backset:	2 3/4" standard
Strike:	1 1/4" x 4 7/8" strike included
Handing:	Specify RH or LH when ordering. Lock is reversible in the field.
Power:	5 AA alkaline batteries (included)
Door Prep:	Standard ANSI A115 mortise prep, modified by adding additional through-bolt holes
Compliances:	Steelcase lock body meets BHMA specifications for Grade 1 locks UL Listed 10C Positive Pressure Specification. FCC Certified ADA compliant levers
Functions:	Deadbolt function only. Features stainless steel deadbolt with 1" (2.55cm) projection, latch bolt with 3/4" (1.91cm) projection and deadlocking latch. Deadbolt may be projected from key cylinder from outside door or turn-piece from inside door.
Cylinder:	1 3/8" (3.5cm) mortise cylinder supplied. Will accept 1 3/8" to 1 1/2" (3.5 - 3.8cm) mortise cylinder.
Cams:	Supplied with cloverleaf cam. Cams for other manufacturer's cylinder are available. See 'Privacy Mortise Lock accessories' for part numbers and manufactures.



**ALL PDL4500 LOCKS ARE WEATHER-RESISTANT
PLEASE CHECK WITH FACTORY FOR LEAD TIMES ON SPECIAL FINISHES**

PRODUCT	FINISH	LIST PRICE
PDL4500DBR Straight lever deadbolt function Right hand	US26D US3 & US10B	\$1,664.00 \$1,744.00
PDL4500DBL Straight lever deadbolt function Left Hand	US26D US3 & US10B	\$1,664.00 \$1,744.00
PDL4575DBR Regal (curved) lever deadbolt Function right hand	US26D US3 & US10B	\$1,682.00 \$1,757.00
PDL4575DBL Regal (curved) lever deadbolt Function right hand	US26D US3 & US10B	\$1,682.00 \$1,757.00
PDL4500SK/26D	Mounted Sales Demo	Call Factory
AL-PCI2	Computer interface cable for serial connection includes DL-Windows software	\$129.00
ALPCI2-U	USB computer interface cable includes DL-Windows software	\$237.00
MX1130	USB Converter	\$118.00
AL-IR1	Infra-red Printer	\$520.00
AL-DTMIII	Data Transfer Module	\$448.00
AL-PRE2	Prox Card Enroller - HID and iClass	\$590.00



ALARM LOCK

Price Book 2019

PRIVACY MORTISE LOCK ACCESSORIES

ALID1326	Proximity Access Cards 100 Per Box	\$505.00
ALHID1336	Proximity, Magnetic Stripe and Photo ID cards 100 per box	\$1,030.00
ALHID1386	Proximity and Photo ID Card 100 per box	\$927.00
ALHID1391	MicroProx Tag 10 per box	\$82.00
ALHID1346	Proximity keyfob 10 per box	\$118.00
ALTRAINDVD	Trilogy DL-Windows and Networx Connectivity software training videos divided into 4 easy to follow sections conducted into a classroom style environment. Training videos cover basics, getting started, schedules and times zones, programming Trilogy locks via a laptop and the DTM along with how to connect and bring Networx on line.	\$0.00 + \$15.95 shipping and handling charge. Please contact customer service at 1-800-ALA-LOCK to place your order via credit card, or email sales@alarmlock.com

PRIVACY MORTISE LOCK PARTS

DEADBOLT FUNCTION CAMS		
HW957-L	Alarm Lock Standard Cloverleaf Cam	\$5.00
HW957-M	Marks Cloverleaf Cam	\$5.00
HW957-C	Corbin-Russwin Cloverleaf Cam	\$5.00
HW957-S	Schalge Cloverleaf Cam	\$5.00
HW957-A	Arrow Cloverleaf Cam	\$5.00
HW957-S	Sargent Cloverleaf Cam	\$5.00
HW1141	Schlage IC Cloverleaf Cam	\$5.00

S6175	Replacement lever support spring	\$3.00
S6192	Lever and spring upgrade kit Standard lever – 26D, 10B, US3	\$54.00
S6193	Lever and spring upgrade kit Regal lever – 26D, 10B, US3	\$80.00
HW904DBR	Right hand deadbolt lock body	\$171.00
HW903DBL	Left hand deadbolt lock body	\$171.00
S6065	Replacement Battery Pack	\$38.00
S6174	Serviceable Replacement Battery Pack	\$48.00



TRILOGY NARROW STYLE LOCK PRODUCTS

DL1200 SERIES – Aluminum door retrofit outside trim. Works with Adams Rite® 4500, 4700 & 4900 series deadlatch. 4070, MS18505 & MS19505 series deadbolts. 100 user codes, master, Manager, basic user and 3 “one-time” user codes.

SPECIFICATIONS:

Door Thickness:	Supports stile 1 3/4" only
Backset:	Supports 3 1/32", 1 1/8", and 1 1/2"
Handing:	Non-handed
Power:	Uses 2 DL123A lithium batteries
Keypad:	All metal, 12 button.
Cylinder:	Supplied with 6 pin standard mortise cylinder in SC1 keyway 1 3/8" or 1 1/2" cylinders supported
Cams:	Cam supplied works with generic Alarm Lock cylinder. Other standard cams available for Corbin-Russwin, Marks, Arrow, Sargent and Schlage. IC type cams for Best, Corbin-Russwin, Medeco, Schlage and Yale are also available.



ALL DL1200 SERIES LOCKS ARE WEATHER-RESISTANT

PRODUCT	DESCRIPTION	LIST PRICE
DL1200/26D1	Lever set works with Adams Rite® 4500, 4700, & 4900 series deadlatch 26D finish	\$706.00
DL1200/10B1	Lever set works with Adams Rite® 4500, 4700 & 4900 series deadlatch 10B finish	\$706.00
DL1225/26D2	Thumb turn works with Adams Rite® 4070, MS18505, MS1950 series deadbolt 26D finish	\$706.00
DL1225/10B2	Thumb turn works with Adams Rite® 4070, MS18505, MS1950 series deadbolt 10B finish	\$706.00
DL1250/26D2	Knob works with Adams Rite® 4070, MS18505, MS1950 series deadbolt 26D finish	\$706.00
DL1250/10B2	Knob works with Adams Rite® 4070, MS18505, MS1950 series deadbolt 10B finish	\$706.00



Price Book 2019

TRILOGY NARROW STYLE LOCK PRODUCTS

DL1300 SERIES – Aluminum door retrofit outside trim. Works with Adams Rite® 1850, 1950, 4710, 4070, 4730, 4900 series spring latch and MS18505 & MS19505 series deadbolts. 2,000 user codes, master, Manager, basic user and multiple “one-time” user codes. 500 event schedule, real time clock & 40,000 event audit trail.



SPECIFICATIONS:

- Door Thickness:** Supports stile 1 3/4" only
- Backset:** Supports 3 1/32", 1 1/8", and 1 1/2"
- Handing:** Non-handed
- Power:** Uses 2 DL123A lithium batteries
- Keypad:** All metal, 12 button.
- Cylinder:** Supplied with 6 pin standard mortise cylinder in SC1 keyway
1 3/8" or 1 1/2" cylinders supported
- Cams:** Cam supplied works with generic Alarm Lock cylinder. Other standard cams available for Corbin-Russwin, Marks, Arrow, Sargent and Schlage. IC type cams for Best, Corbin-Russwin, Medeco, Schlage and Yale are also available.



ALL DL1300 SERIES LOCKS ARE WEATHER RESISTANT

PRODUCT	DESCRIPTION	LIST PRICE
DL1300/26D1	Lever set works with Adams Rite® 4500, 4700, & 4900 series deadlatch 26D finish	\$843.00
DL1300/10B1	Lever set works with Adams Rite® 4500, 4700, & 4900 series deadlatch 10B finish	\$843.00
DL1325/26D2	Thumb turn works with Adams Rite® 4070, MS18505, MS1950 series deadbolt 26D finish	\$843.00
DL1325/10B2	Thumb turn works with Adams Rite® 4070, MS18505, MS1950 series deadbolt 10B finish	\$843.00
DL1350/26D2	Knob works with Adams Rite® 4070, MS18505, MS1950 series deadbolt 26D finish	\$843.00
DL1350/10B2	Knob works with Adams Rite® 4070, MS18505, MS1950 series deadbolt 10B finish	\$843.00
AL-PCI2	Computer interface cable for serial connection includes DL-Windows software	\$129.00
ALPCI2-U	USB computer interface cable includes DL-Windows software	\$237.00
AL-IR1	Infra-red Printer	\$520.00
AL-DTMIH	Data Transfer Module	\$448.00

TRILOGY NARROW STILE LOCK PRODUCTS

PDL1300 SERIES – Aluminum door retrofit outside trim. Works with Adams Rite® 1850, 1950, 4710, 4070, 4730, 4900 series spring latch and MS18505 & MS19505 series deadbolts. 2,000 user codes, master, Manager, basic user and multiple “one-time” user codes. 500 event schedule, real time clock & 40,000 event audit trail.



SPECIFICATIONS:

Door Thickness:	Supports stile 1 3/4" only
Backset:	Supports 3 1/32", 1 1/8", and 1 1/2"
Handing:	Non-handed
Power:	Uses 2 DL123A lithium batteries
Keypad:	All metal, 12 button.
Cylinder:	Supplied with 6 pin standard mortise cylinder in SC1 keyway 1 3/8" or 1 1/2" cylinders supported
Cams:	Cam supplied works with generic Alarm Lock cylinder. Other standard cams available for Corbin-Russwin, Marks, Arrow, Sargent and Schlage. IC type cams for Best, Corbin-Russwin, Medeco, Schlage and Yale are also available.

ALL NARROW STILE LOCKS ARE WEATHER-RESISTANT

PRODUCT	DESCRIPTION	LIST PRICE
PDL1300/26D1	Lever set works with Adams Rite® 4500, 4700, & 4900 series deadlatch 26D finish	\$1,222.00
PDL1300/10B1	Lever set works with Adams Rite® 4500, 4700, & 4900 series deadlatch 10B finish	\$1,222.00
PDL1325/26D2	Thumb turn works with Adams Rite® 4070, MS18505, MS1950 series deadbolt 26D finish	\$1,222.00
PDL1325/10B2	Thumb turn works with Adams Rite® 4070, MS18505, MS1950 series deadbolt 10B finish	\$1,222.00
PDL1350/26D2	Knob works with Adams Rite® 4070, MS18505, MS1950 series deadbolt 26D finish	\$1,222.00
PDL1350/10B2	Knob works with Adams Rite® 4070, MS18505, MS1950 series deadbolt 10BD finish	\$1,222.00
AL-PCI2	Computer interface cable for serial connection includes DL-Windows software	\$129.00



TRILOGY NARROW STYLE LOCK PRODUCTS (con't)

ALPCI2-U	USB computer interface cable includes DL-Windows software	\$237.00
MX1130	USB Converter	\$118.00
AL-IR1	Infra-red Printer	\$520.00
AL-DTMIII	Data Transfer Module	\$448.00
AL-PRE2	Prox Card Enroller - HID and iCladd	\$590.00
ALID1326	Proximity Access Cards 100 Per Box	\$520.00
ALHID1336	Proximity, Magnetic Stripe and Photo ID cards 100 per box	\$1,030.00
ALHID1386	Proximity and Photo ID Card 100 per box	\$927.00
ALHID1391	MicroProx Tag 10 per box	\$82.00
ALHID1346	Proximity keyfob 10 per box	\$118.00

PARTS

STANDARD MORTISE CAMS	DESCRIPTION	LIST PRICE
HW1344	Corbin-Russwin standard cam	\$5.00
HW1346	Marks standard cam	\$5.00
HW1348	Arrow & Sargent standard cams	\$5.00
HW1349	Schlage standard cam	\$5.00
IC MORTISE CAMS		
HW1345	Corbin-Russwin IC cam	\$11.00
HW1347	Medeco IC cam	\$11.00
HW1350	Schlage IC cam	\$11.00
HW1343	Best IC cam	\$11.00
S6169	Best IC housing with cam attached 26D, 10B	\$42.00
Replacement Battery		
S6161	Inside Battery Kit	\$61.00
S6170	Replacement Battery	\$38.00

HOW TO ORDER THE TRILOGY NARROW STILE LOCKS

Last two digits of the part number are

Used with Adams Rite Product

00 Straight Lever

4500, 4700 & 4900 Series Only

25 Thumb turn

MS1850, MS1950 & 4070 Series

50 Knob

MS1850, MS1950 & 4070 Series



TRILOGY NARROW STYLE/EXIT LOCK PRODUCTS

DL1200ET, DL1300ET & PDL1300ET SERIES - Aluminum door retrofit outside trim. Works with Marks, Arrow, DCI, Von Duprin, Corbin, Dor-o-matic, Dorma & Jackson. DL1200ET has 100 user codes, master, Manager, basic user and 3 “one-time” user codes. DL1300ET & PDL1300ET have 2,000 user codes, multiple “one-time” user codes. 500 event schedule, real time clock & 40,000 event audit trail. PDL1300ET also has proximity capabilities.

SPECIFICATIONS:



Door Thickness: Supports stile 1 3/4" only
Backset: Supports 3 1/32", 1 1/8", and 1 1/2"
Handing: Non-handed
Power: Uses 2 DL123A lithium batteries
Keypad: All metal, 12 button.
Cylinder: Supplied with 6 pin standard mortise cylinder in SC1 keyway
 1 3/8" or 1 1/2" cylinders supported
Cams: Cam supplied works with generic Alarm Lock cylinder. Other standard cams available for Corbin-Russwin, Marks, Arrow, Sargent and Schlage. IC type cams for Best, Corbin-Russwin, Medeco, Schlage and Yale are also available.



**Must order separate tailpiece for specific ET being installed
 (See page 31)**

Note: ET Trim works w/V33 LH (RHR) only

ALL NARROW STILE/EXIT LOCKS ARE WEATHER-RESISTANT

PRODUCT	DESCRIPTION	LIST PRICE
DL1200ET/26D STRAIGHT LEVER 100 user codes	Narrow Stile Lock for Arrow S1200/S1250, Marks 8800, DCI 1200/1300, Von Duprin 22, Corbin ED8200 & Von Duprin 33 panic LH (RHR) devices only	\$706.00
DL1200ET//10B STRAIGHT LEVER 100 user codes	Narrow Stile Lock for Arrow S1200/S1250, Marks 8800, DCI 1200/1300, Von Duprin 22, Corbin ED8200 & Von Duprin 33 panic LH (RHR) devices only	\$706.00
DL1225ET/26D TURNPIECE 100 user codes	Narrow Stile lock for Dor-o-Matic 2090, Jackson 1095 & Dorma 5300 panic devices	\$706.00
DL1225ET/10B TURNPIECE 100 user codes	Narrow Stile lock for Dor-o-Matic 2090, Jackson 1095 & Dorma 5300 panic devices	\$706.00
DL1250ET/26D KNOB 100 user codes	Narrow Stile lock for Dor-o-Matic 2090, Jackson 1095 & Dorma 5300 panic devices	\$706.00



Price Book 2019

TRILOGY NARROW STYLE/EXIT LOCK PRODUCTS (CON'T)

DL1250ET/10B KNOB 100 user codes	Narrow Stile lock for Dor-o-Matic 2090, Jackson 1095 & Dorma 5300 panic devices	\$706.00
DL1300ET/26D STRAIGHT LEVER 2,000 user codes	Narrow Stile Lock for Arrow S1200/S1250, Marks 8800, DCI 1200/1300, Von Duprin 22, Corbin ED8200 & Von Duprin 33 panic LH (RHR) devices only	\$878.00
DL1300ET/10B STRIGHT LEVER 2,000 user codes	Narrow Stile Lock for Arrow S1200/S1250, Marks 8800, DCI 1200/1300, Von Duprin 22, Corbin ED8200 & Von Duprin 33 panic LH (RHR) devices only	\$878.00
DL1325ET/26D TURNPIECE 2,000 user codes	Narrow Stile lock for Dor-o-Matic 2090, Jackson 1095 & Dorma 5300 panic devices	\$878.00
DL1325ET/210B TURNPIECE 2,000 user codes	Narrow Stile lock for Dor-o-Matic 2090, Jackson 1095 & Dorma 5300 panic devices	\$878.00
DL1350ET/26D KNOB 2,000 user codes	Narrow Stile lock for Dor-o-Matic 2090, Jackson 1095 & Dorma 5300 panic devices	\$878.00
DL1350ET/10B KNOB 2,000 user codes	Narrow Stile lock for Dor-o-Matic 2090, Jackson 1095 & Dorma 5300 panic devices	\$878.00
PDL1300ET/26D STRAIGHT LEVER 2,000 user codes	Narrow Stile Lock for Arrow S1200/S1250, Marks 8800, DCI 1200/1300, Von Duprin 22, Corbin ED8200 & Von Duprin 33 panic LH (RHR) devices only	\$1,222.00
PDL1300ET/10B STRAIGHT LEVER 2,000 user codes	Narrow Stile Lock for Arrow S1200/S1250, Marks 8800, DCI 1200/1300, Von Duprin 22, Corbin ED8200 & Von Duprin 33 panic LH (RHR) devices only	\$1,222.00
PDL1325ET/26D TURNPIECE 2,000 user codes	Narrow Stile lock for Dor-o-Matic 2090, Jackson 1095 & Dorma 5300 panic devices	\$1,222.00
PDL1325ET/10B TURNPIECE 2,000 user codes	Narrow Stile lock for Dor-o-Matic 2090, Jackson 1095 & Dorma 5300 panic devices	\$1,222.00
PDL1350ET/26D KNOB 2,000 user codes	Narrow Stile lock for Dor-o-Matic 2090, Jackson 1095 & Dorma 5300 panic devices	\$1,222.00
PDL1350ET/10B KNOB 2,000 user codes	Narrow Stile lock for Dor-o-Matic 2090, Jackson 1095 & Dorma 5300 panic devices	\$1,222.00



Price Book 2019

TRILOGY NARROW STYLE/EXIT LOCK PRODUCTS (CON'T)

Tailpieces must be used with the Panic Devices as shown below

TAILPIECE PART NUMBER	PANIC DEVICE	LIST PRICE
TP-1691	Used with Arrow S1200/1250, DCI 1200/1300, Von Duprin 22 & Dorma 5300, Marks 8800 Panic Devices	\$57.00
TP-1692	Used with Dor-o-Matic 2090 Panic Device	\$57.00
TP-1693	Used with Corbin ED8200 Panic Device	\$57.00
TP-1694	Used with Von Duprin 33 LH (RHR) devices only	\$57.00
TP-1698	Used with Jackson 1095 Panic Device	\$57.00

TRILOGY NARROW STYLE/EXIT LOCK PRODUCTS

PARTS AND ACCESSORIES

ACCESSORIES	DESCRIPTION	LIST PRICE
AL-PCI2	Computer interface cable for serial connection includes DL-Windows software	\$129.00
ALPCI2-U	USB computer interface cable includes DL-Windows software	\$237.00
MX1130	USB Converter	\$120.00
AL-IR1	Infra-red Printer	\$520.00
AL-DTMIII	Data Transfer Module	\$448.00
AL-PRE2	Prox Card Enroller - HID and iClass	\$590.00
ALID1326	Proximity Access Cards 100 Per Box	\$505.00
ALHID1336	Proximity, Magnetic Stripe and Photo ID cards 100 per box	\$1,030.00
ALHID1386	Proximity and Photo ID Card 100 per box	\$927.00
ALHID1391	MicroProx Tag 10 per box	\$82.00
ALHID1346	Proximity keyfob 10 per box	\$118.00

STANDARD MORTISE CAMS	DESCRIPTION	LIST PRICE
HW1344	Corbin-Russwin standard cam	\$5.00
HW1346	Marks standard cam	\$5.00
HW1348	Arrow & Sargent standard cams	\$5.00
HW1349	Schlage standard cam	\$5.00
IC MORTISE CAMS		
HW1345	Corbin-Russwin IC cam	\$11.00
HW1347	Medeco IC cam	\$11.00
HW1350	Schlage IC cam	\$11.00
HW1343	Best IC cam	\$11.00
S6169	Best IC housing w/cam attached 26D, 10B	\$42.00
Replacement Battery		
S6161	Inside Battery Kit	\$61.00
S6170	Replacement Battery	\$38.00

TRILOGY EXIT TRIM PRODUCTS

Battery operated Trilogy outside trim works with Marks M9900, Von Duprin 99, Corbin ED5000, Yale 7100, Dorma 9300, Arrow 3800, Sargent 8800, Precision 1100, 2100 & Cal Royal 9800, Hager 4500 series panic devices. Available in DL series (keypad) or PDL (prox/keypad) formats. Features include 2,000 user codes, 500 scheduled events and 40,000 event audit trail.

SPECIFICATIONS:

- Door Thickness:** Standard model fits 1 5/8" to 1 7/8"
- Handing:** Non-handed
- Power:** 5 AA alkaline batteries (included) mounted on the inside of door
- Keypad:** Weather-resistant all metal, 12 button. All functions programmed through keypad.
- Cylinder:** Use standard rim cylinder to operate key override function.
Will accept 6 or 7 pin interchangeable core cylinders (see below).

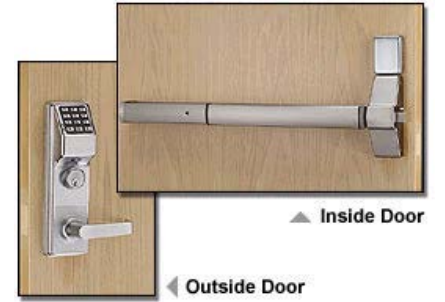

crash bar not included except with M99 kit.

ALL ET SERIES LOCKS ARE WEATHER-RESISTANT
PLEASE CHECK WITH FACTORY FOR LEAD TIMES ON SPECIAL FINISHES

PRODUCT	DESCRIPTION	LIST PRICE
ETDL series	26D	\$1,320.00
ETDL series	US3 & US10B	\$1,388.00
ETDL series w/Regal lever	26D	\$1,343.00
ETDL series w/Regal lever	US3 & US10B	\$1,400.00
ETPDL series	26D	\$1,722.00
ETPDL series	US3 & US10B	\$1,792.00
ETPDL series w/Regal lever	26D	\$1,744.00
ETPDL series w/Regal lever	US3 & US10B	\$1,812.00
ETPL series	26D	\$1,722.00
	US3 & US10B	\$1,792.00
ETPL series w/Regal lever	26D	\$1,744.00
	US3 & US10B	\$1,812.00
Specify finish on adapter kit ET- AL Finish = 26D, US3 & US10B	Alarm Lock Standard Rim Cylinder Adapter kit (Schlage C keyway)	\$57.00
ET- AR Finish = 26D, US3 & US10B	Arrow Standard Rim Cylinder Adapter kit	\$57.00
ET- AS Finish = 26D, US3 & US10B	ASSA Standard Rim Cylinder Adapter kit	\$57.00
ET - C Finish = 26D, US3 & US10B	Corbin Standard Rim Cylinder Adapter kit	\$57.00
ET - M Finish = 26D, US3 & US10B	Medeco Standard Rim Cylinder Adapter kit	\$57.00
ET - R Finish = 26D, US3 & US10B	Sargent Standard Rim Cylinder Adapter kit	\$57.00
ET - S Finish = 26D, US3 & US10B	Schlage Standard Rim Cylinder Adapter kit	\$57.00
ET - Y Finish = 26D, US3 & US10B	Yale Standard Rim Cylinder Adapter kit	\$57.00
ET - ARIC Finish = 26, 26D, 3, 4, 5, 10B	Arrow IC 6 & 7 Pin Rim Cylinder Adapter kit	\$79.00
ET - BIC Finish = 26D, US3 & US10B	Best IC 6 & 7 Pin Rim Cylinder Adapter kit	\$79.00
ET - CIC Finish = 26D, US3 & US10B	Corbin IC Rim Cylinder Adapter kit	\$79.00
ET - MIC Finish = 26D, US3 & US10B	Medeco IC 6 & 7 Pin Rim Cylinder Adapter kit	\$79.00



TRILOGY EXIT TRIM PRODUCTS (CONT'D)

Product	Description	LIST PRICE
ET - RIC Finish = 26D, US3 & US10B	Sargent IC Rim Cylinder Adapter kit	\$79.00
ET - SIC Finish = 26D, US3 & US10B	Schlage IC Rim Cylinder Adapter kit	\$79.00
ET - YIC Finish = 26D, US3 & US10B	Yale IC 6 Pin Rim Cylinder Adapter kit	\$79.00
ETDLSKG/26DM99	Mounted sales kit For demo purposes	Call Factory
ETPDLSKG/26DM99	Mounted sales kit For demo purposes	Call Factory
AL-PCI2	Computer interface cable for serial connection Includes DL-Windows software	\$129.00
ALPCI2-U	USB computer interface cable includes DL-Windows software	\$ 230.00
AL-IR1	Infra-red Printer	\$520.00
AL-DTMIII	Data Transfer Module	\$448.00
AI-PRE2	Prox Card Enroller - HID and iClass	\$590.00
ALID1326	Proximity Access Cards 100 per box	\$470.00
ALHID1336	Proximity, Magnetic Stripe and Photo ID cards 100 per box	\$1,030.00
ALHID1386	Proximity and Photo ID Card 100 per box	\$927.00
ALHID1346	Proximity keyfob packed 10 per box	\$118.00
ALHID1391	MicroProx Tag 10 per box	\$82.00

EXIT TRIM KITS W/MARKS M9900 PANIC BAR

PRODUCT	DESCRIPTION	LIST PRICE
ETDL-M99K	26D Finish	\$1,729.00
ETPDL-M99K	26D Finish	\$2,118.00

EXTENDED SPINDLES CAN BE PURCHASED SEPARATELY

S6146 Extended Spindle and screws	Extend exit trim to fit 2 - 2 3/4" doors	\$112.00
S6147 Extended Spindle and screws	Extend exit trim to fit 3 - 4" doors	\$112.00
S6195 Extended Spindle and screws	Extend exit trim to fit 4 1/4 - 5" doors	\$112.00
SC544	Extended replacement screws with adjustable lengths (4 per unit)	\$21.00 each
S6174	Serviceable Replacement Battery Pack	\$48.00
S6175	Lever return spring for ET	\$3.00
S6190	Exit Trim/Mortise Lock Parts Kit	\$151.00
S6191	Lever and spring upgrade kit Standard lever - 26D, 10B	\$61.00
S6193	Lever and spring upgrade kit Regal lever - 26D, 10B	\$78.00

PLEASE SEE "HOW TO ORDER" CHART ON NEXT PAGE TO PROPERLY ORDER YOUR TRILOGY EXIT TRIM.

IF YOU REQUIRE THE LOCK TO BE PREPPED FOR A THICKER DOOR, YOU MUST ORDER BASED ON THE SELECTIONS SHOWN. THE BASIC MODEL IS PREPPED FOR A 1 5/8" TO 1 7/8" DOOR.

**** PRECISION 2100 SERIES WILL WORK WITH THE VON DUPRIN 99 PREP. YOU MUST GET A MOUNTING PLATE PART # BP21 FROM PRECISION****



HOW TO ORDER YOUR TRILOGY EXIT LOCK

Below is a “How to Order” guide for the Trilogy Exit Trim products. Please follow this guide when placing orders to avoid any delay in processing your order.

All units are sold with a generic cylinder adapter installed. When you are using a specific Brand of rim cylinder, you must purchase a Cylinder Adapter Kit from the chart below.

ETPDLS1G/26DV99

TYPE
 PDL Digital w/Prox
 PL Prox only
 DL Keypad only

HANDLE
 R-Regal
 S-Straight

DOOR THICKNESS
 1=1 3/4” + 1/8”
All units shipped with “1” option.

For thicker door preps, you must order extended spindle and screw kit separately.

G= generic rim cylinder & adapter kit included in all locks

COMPATABLE PANIC DEVICES
 V99 – VonDuprin 99(P21, Hager 4500)
 C50 – Corbin ED5000
 Y71 - Yale 7100
 D93 – Dorma 9300
 A38 – Arrow 3800
 S88 – Old Style Sargent 8800 NS8 –
 New Style Sargent 8888 P11 - Precision
 1100
 CR8 – Cal Royal 9800
 M99 - Marks 9900

FINISH
 26D = satin chrome
 10B = duronodic

Please note that Precision 2100 series will match up to the Von Duprin 99 series Trilogy. You must get a mounting plate #BP21 from Precision.

CYLINDER ADAPTER KITS
 You must choose one of the cylinder adapter kits below if you are using a name brand cylinder in the lock.

ET - AL	- Alarm Lock standard (Schlage C keyway)
ET – BIC	- Best IC 6 & 7 pin
ET – S	- Schlage standard rim
ET – SIC	- Schlage IC
ET – R	- Sargent standard rim
ET – RIC	- Sargent IC
ET – Y	-Yale standard rim
ET – YIC	-Yale IC 6 pin
ET - C	- Corbin standard rim
ET – CIC	- Corbin IC
ET - M	- Medeco standard rim
ET – MIC	- Medeco IC 6 & 7 pin
ET – AR	- Arrow standard rim
ET – ARIC	- Arrow IC 6 & 7 pin
ET – AS	- ASSA standard rim



TRILOGY ELECTRONIC DIGITAL KEYPAD

DK3000/PDK3000 Series - Electronic digital keypad. Available in keypad only and keypad plus prox. Holds up to 2,000 user codes, Master, Management, Supervisor & basic user. 500 event schedule, real time clock & 40,000 event audit trail. Prox unit will read most HID cards and keyfobs.

Specifications:

- Wall mount:** Single gang mounting
- Wiring:** Unit provides flying leads for power, relays, tamper and remote release
- I/O Specs:** 2 form C relays 5AMP minimum contact rating. Red and green LED indicators. 1 remote release input. Sounder and tamper.
- Power:** Operating voltage 12-24VAC/DC field selectable



ALL DK3000/PDK3000 ARE WEATHER-RESISTANT

PRODUCT	FINISH	LIST PRICE
DK3000	Metallic silver (MS) Metallic bronze (MB)	\$642.00
	26D, US3 & US10B	\$838.00
PDK3000	Metallic silver (MS) Metallic bronze (MB)	\$1,067.00
	26D, US3 & US10B	\$1,211.00
AL-PCI2	Computer interface cable for serial connection includes DL-Windows software	\$129.00
ALPCI2-U	USB computer interface cable includes DL-Windows software	\$237.00
MX1130	USB Converter	\$118.00
AL-IR1	Infra-red Printer	\$520.00
AL-DTMIII	Data Transfer Module	\$448.00
AL-PRE2	Prox Card Enroller - HID and iClass	\$590.00
ALID1326	Proximity Access Cards 100 per box	\$505.00
ALHID1336	Proximity, Magnetic Stripe and Photo ID cards 100 per box	\$1,030.00
ALHID1386	Proximity and Photo ID Card 100 per box	\$927.00
ALHID1346	Proximity keyfob packed 10 per box	\$118.00
ALHID1391	MicroProx Tag 10 per box	\$82.00
ALTRAINDVD	Trilogy DL-Windows and Networx Connectivity software training videos divided into 4 easy to follow sections conducted into a classroom style environment. Training videos cover basics, getting started, schedules and times zones, programming Trilogy locks via a laptop and the DTM along with how to connect and bring Networx on line.	\$0.00 + \$15.95 shipping and handling charge. Please contact customer service at 1-800-ALA-LOCK to place your order via credit card, or email sales@alarmlock.com



TRILOGY NETWORKX DIGITAL LOCKS

DL6100 SERIES — Digital cylindrical lock supporting 5,000 pin user codes (3-6 digits), 500 scheduled events and 35,000 event audit log.

SPECIFICATIONS:



Door Thickness: Fits 1 5/8" to 1 7/8". Other thickness, refer to chart to the right.
Backset: 2 3/4" (2 3/8" also available. Must specify when ordering)
Strike: 1 1/8" x 2 3/4" T strike & 1 1/4" x 4 7/8" ASA strike included
Latch bolt: UL Listed, fire rated 3 hours, 1/2" throw, reversible
Handing: Non-handed
Power: 4 C-cell batteries (included)
Keypad: All metal, 12 button. Basic functions programmed through keypad
Door Prep: Standard ANSI A115 Series prep, modified by adding additional through-bolt holes
Compliances: BHMA Certified Grade 1 heavy duty cylindrical lockset
 UL Listed 10C Positive Pressure Specification. FCC Certified
 ADA compliant levers
Cylinder: 6 pin solid brass. SCY1 keyway furnished with all key override locks
 Schlage, Corbin-Russwin CL, Sargent 480 series, ASSA 65-611 & Lori cylinders can be used with the HW620 tailpiece (supplied)
Interchangeable Core Models: Standard model accepts 6 & 7 pin cylinders from Best, Falcon, Arrow, KSP, Medeco Keymark & Kaba Peaks.
 IC core models prepped for 6 & 7 pin Yale and Corbin-Russwin
 IC core models prepped for 6 pin Medeco, Sargent, and Schlage

Extended sizes:
 Standard and SFIC cylinder preps can be extended for thicker doors.

\$165.00 add on to list for extended lock.

Extended lock legend:
 W54 - 2 1/8"
 W57 - 2 1/4"
 W60 - 2 3/8"
 W64 - 2 1/2"
 W70 - 2 3/4"
 W76 - 3"
 W83 - 3 1/4"
 W89 - 3 1/2"

Note: Locks can be adjusted by +/- 1/8" by adding or removing spacers.

**ALL NETWORKX LOCKS ARE WEATHER RESISTANT
 PLEASE CHECK WITH FACTORY FOR LEAD TIMES ON SPECIAL FINISHES AND IC PREPS**

PRODUCT	FINISH	LIST PRICE
DL6100	26D	\$1,452.00
Standard key override	10B	\$1,534.00
DL6175		
Standard Key override	26D	\$1,472.00
Regal (curved)	10B	\$1,586.00
DL6100IC*	26D	\$1,472.00
Interchangeable core	10B	\$1,550.00
DL6175IC*		
Interchangeable core	26D	\$1,503.00
Regal (curved)	10B	\$1,565.00
AL-IME2	Ethernet connected gateway w/AC adapter to plug into standard wall outlet. Version 2 - allow use of expander	\$475.00
AL-IM2-80211	Wi-Fi gateway to connect to 802.11 network w/AC adapter to plug into standard wall outlet. Version 2 - allow use of expander	\$675.00
AL-IME2-POE	Power Over Ethernet, plus hardwire gateway interface capability. No AC Power required. Version 2 - allow use of expander	\$575.00
AL-IME2-EXP	Wireless expander designed to expand the coverage area of version 2 gateways. AC power required. Up to 7 expanders per version 2 gateway	\$250.00

*Add "C" for Corbin, "M" for Medeco, "R" for Sargent, "Y" for Yale and "S" for Schlage to end of the part number for specially prepped IC core models. Add \$15.00 to the list price shown above. **MUST SPECIFY 7 PIN FOR CORBIN AND YALE** For small format Medeco IC, specify SFIC prep.

Networkx training options available. See page 45 for details.



TRILOGY NETWORKX PROXIMITY DIGITAL LOCKS

PDL6100/PDL6200— Prox and digital cylindrical lock supporting 5,000 PIN user codes (3-6 digits), and/or HID Proximity cards. 500 scheduled events and 35,000 event audit log.

SPECIFICATIONS:



Door Thickness: Fits 1 5/8" to 1 7/8". Other thickness, refer to chart to the right.
Backset: 2 3/4" (2 3/8" also available. Must specify when ordering)
Strike: 1 1/8" x 2 3/4" T strike & 1 1/4" x 4 7/8" ASA strike included
Latch bolt: UL Listed, fire rated 3 hours, 1/2" throw, reversible
Handing: Non-handed
Power: 4 C-cell batteries (included)
Keypad: All metal, 12 button. Basic functions programmed through keypad
Door Prep: Standard ANSI A115 Series prep, modified by adding additional through-bolt holes
Compliances: BHMA Certified Grade 1 heavy duty cylindrical lockset
 UL Listed 10C Positive Pressure Specification. FCC Certified
 ADA compliant levers
Cylinder: 6 pin solid brass. SCY1 keyway furnished with all key override locks
 Schlage, Corbin-Russwin CL, Sargent 480 series, ASSA 65-611 & Lori cylinders can be used with the HW620 tailpiece (supplied)
Interchangeable Core Models: Standard model accepts 6 & 7 pin cylinders from Best, Falcon, Arrow, KSP, Medeco Keymark & Kaba Peaks.
 IC core models prepped for 6 & 7 pin Yale and Corbin-Russwin
 IC core models prepped for 6 pin Medeco, Sargent, and Schalge

Extended sizes:
 Standard and SFIC cylinder preps can be extended for thicker doors.

\$165.00 add on to list for extended lock.

Extended lock legend:

- W54 - 2 1/8"
- W57 - 2 1/4"
- W60 - 2 3/8"
- W64 - 2 1/2"
- W70 - 2 3/4"
- W76 - 3"
- W83 - 3 1/4"
- W89 - 3 1/2"

Note: Locks can be adjusted by +/- 1/8" by adding or removing spacers.

**ALL NETWORKX LOCKS ARE WEATHER RESISTANT
 PLEASE CHECK WITH FACTORY FOR LEAD TIMES ON SPECIAL FINISHES AND IC PREPS**

PRODUCT	FINISH	LIST PRICE
PDL6100	26D	\$1,864.00
Standard key override	10B	\$1,936.00
PDL6200		
Standard Key override	26D	\$1,915.00
w/door position switch	10B	\$1,987.00
PDL6175		
Standard Key override	26D	\$1,890.00
Regal (curved)	10B	\$1,951.00
PDL6100IC*	26D	\$1,879.00
Interchangeable core	10B	\$1,946.00
PDL6175IC*		
Interchangeable core	26D	\$1,962.00
Regal (curved)	10B	\$2,060.00
PDL6100SK	Mounted PDL6100 demo w/ mounted sales/demo kit including IME gateway and router mounted on plexi-glass for plug and play demonstrations with Alarm Lock carrying bag.	\$2,0000
AL-IME2	Ethernet connected gateway w/AC adapter to plug into standard wall outlet. Version 2 - allow use of expander	\$475.00
AL-IM2-80211	Wi-Fi gateway to connect to 802.11 network w/AC adapter to plug into standard wall outlet. Version 2 - allow use of expander	\$675.00
AL-IME2-POE	Power Over Ethernet, plus hardware gateway interface capability. No AC Power required. Version 2 - allow use of expander	\$575.00
AL-IME2-EXP	Wireless expander designed to expand the coverage area of version 2 gateways. AC power required. Up to 7 expanders per version 2 gateway	\$250.00

AL-IME2-PIE	Plug-in wireless expander expands the coverage area of ver 2 gateways. Plugs into standard AC outlet. Up to 7 expanders per ver 2 gateway.	\$250.00
AL-PRE2	Prox Card Enroller - HID and iClass	\$590.00
ALID1326	Proximity Access Cards 100 Per Box	\$505.00
ALHID1336	Proximity, Magnetic Stripe and Photo ID cards 100 per box	\$1,030.00
ALHID1386	Proximity and Photo ID Card 100 per box	\$927.00
ALHID1391	MicroProx Tag 10 per box	\$82.00
ALHID1346	Proximity keyfob 10 per box	\$118.00
S6196	Networkx Replacement Battery Pack	\$45.00
AL-IME-USB	USB Gateway	\$300.00
AL-NSM	Networkx Signal Meter	\$296.00
AL-NSG	Networkx Signal Generator	\$240.00

*Add "C" for Corbin, "M" for Medeco, "R" for Sargent, "Y" for Yale and "S" for Schlage to end of the part number for specially prepped IC core models. Add \$15.00 to the list price shown above. **MUST SPECIFY 7 PIN FOR CORBIN AND YALE** For small format Medeco IC, specify SFIC prep.

Networkx training options available. See below for details.

Note:

Training and education options available for Networkx products:

- 1. FREE On-Line certification Software and Networkx connectivity video training available at: <http://alarmlock.com/trainingvideos-list.asp>**
- 2. On site training may be available thru our in field rep agencies on a quote-by-quote basis. The minimum charge is \$500. For a listing of the reps in your area, please go to our website at: <http://alarmlock.com/contactn.html>**

AL Training DVD

ALTRAINDVD	Trilogy DL-Windows and Networkx Connectivity software training videos divided into 4 easy to follow sections conducted into a classroom style environment. Training videos cover basics, getting started, schedules and times zones, programming Trilogy locks via a laptop and the DTM along with how to connect and bring Networkx on line.	\$0.00 + \$15.95 shipping and handling charge. Please contact customer service at 1-800-ALA-LOCK to place your order via credit card, or email sales@alarmlock.com
------------	---	--



ALARM LOCK

Price Book 2019

TRILOGY NETWORKX PROXIMITY DIGITAL LOCKS

PL6100 SERIES – Prox only cylindrical lock supporting 5,000 PIN user codes (3-6 digits), and/or HID Proximity cards. 500 scheduled events and 35,000 event audit log.

SPECIFICATIONS:



Door Thickness: Fits 1 5/8" to 1 7/8". Other thickness, refer to chart to the right.
Backset: 2 3/4" (2 3/8" also available. Must specify when ordering)
Strike: 1 1/8" x 2 3/4" T strike & 1 1/4" x 4 7/8" ASA strike included
Latch bolt: UL Listed, fire rated 3 hours, 1/2" throw, reversible
Handing: Non-handed
Power: 4 C-cell batteries (included)
Door Prep: Standard ANSI A115 Series prep, modified by adding additional through-bolt holes
Compliances: BHMA Certified Grade 1 heavy duty cylindrical lockset
 UL Listed 10C Positive Pressure Specification. FCC Certified
 ADA compliant levers
Cylinder: 6 pin solid brass. SCY1 keyway furnished with all key override locks
 Schlage, Corbin-Russwin CL, Sargent 480 series, ASSA 65-611 & Lori cylinders can be used with the HW620 tailpiece (supplied)
Interchangeable Core Models: Standard model accepts 6 & 7 pin cylinders from Best, Falcon, Arrow, KSP, Medeco Keymark & Kaba Peaks.
 IC core models prepped for 6 & 7 pin Yale and Corbin-Russwin
 IC core models prepped for 6 pin Medeco, Sargent, and Schlage

Extended sizes:
 Standard and SFIC cylinder preps can be extended for thicker doors.

\$165.00 add on to list for extended lock.

Extended lock legend:
 W54 - 2 1/8"
 W57 - 2 1/4"
 W60 - 2 3/8"
 W64 - 2 1/2"
 W70 - 2 3/4"
 W76 - 3"
 W83 - 3 1/4"
 W89 - 3 1/2"

Note: Locks can be adjusted by +/- 1/8" by adding or removing spacers.

ALL NETWORKX LOCKS ARE WEATHER RESISTANT

PLEASE CHECK WITH FACTORY FOR LEAD TIMES ON SPECIAL FINISHES AND IC PREPS

PRODUCT	FINISH	LIST PRICE
PL6100	26D	\$1,864.00
Standard key override	10B	\$1,936.00
PL6175		
Standard Key override	26D	\$1,890.00
Regal (curved)	10B	\$1,951.00
PL6100IC*	26D	\$1,879.00
Interchangeable core	10B	\$1,946.00
PL6175IC*		
Interchangeable core	26D	\$1,962.00
Regal (curved)	10B	\$2,060.00
AL-IME2	Ethernet connected gateway w/AC adapter to plug into standard wall outlet. Version 2 - allow use of expander	\$475.00
AL-IM2-80211	Wi-Fi gateway to connect to 802.11 network w/AC adapter to plug into standard wall outlet. Version 2 - allow use of expander	\$675.00
AL-IME2-POE	Power Over Ethernet, plus hardware gateway interface capability. No AC Power required. Version 2 - allow use of expander	\$575.00
AL-IME2-EXP	Wireless expander designed to expand the coverage area of version 2 gateways. AC power required. Up to 7 expanders per version 2 gateway	\$250.00
AL-IME2-PIE	Plug-in wireless expander expands the coverage area of ver 2 gateways. Plugs into standard AC outlet. Up to 7 expanders per ver 2 gateway.	\$250.00
AL-PRE2	Prox Card Enroller - HID and iClass	\$590.00
ALID1326	Proximity Access Cards 100 Per Box	\$505.00
ALHID1336	Proximity, Magnetic Stripe and Photo ID cards 100 per box	\$1,030.00
ALHID1386	Proximity and Photo ID Card 100 per box	\$927.00
ALHID1391	MicroProx Tag 10 per box	\$82.00
ALHID1346	Proximity keyfob 10 per box	\$118.00
S6196	Networkx Replacement Battery Pack	\$45.00
AL-IME-USB	USB Gateway	\$300.00
AL-NSM	Networkx Signal Meter	\$296.00
AL-NSG	Networkx Signal Generator	\$240.00

*Add "C" for Corbin, "M" for Medeco, "R" for Sargent, "Y" for Yale and "S" for Schlage to end of the part number for specially prepped IC core models. Add \$15.00 to the list price shown above. *MUST SPECIFY 7 PIN CORBIN AND YALE* For small format Medeco IC, specify SFIC prep.



Price Book 2019

TRILOGY NETWORKX ELECTRONIC DIGITAL MORTISE LOCKS

DL6500 SERIES – Digital mortise lock supporting 5,000 PIN user codes (3-6 digits), 500 scheduled events and 35,000 event audit log.

SPECIFICATIONS:

Door Thickness:	Fits 1 5/8" to 1 7/8"
Backset:	2 3/4" standard
Strike:	1 1/4" x 4 7/8" strike included
Handing:	Specify RH or LH when ordering. Lock is reversible in the field.
Power:	4 C-Cell batteries (included)
Keypad:	All metal, 12 button. Basic functions programmed through keypad
Door Prep:	Standard ANSI A115 mortise prep, modified by adding additional through-bolt holes
Compliances:	Steelcase lock body meets BHMA specifications for Grade 1 locks UL Listed 10C Positive Pressure Specification. FCC Certified ADA compliant levers
Functions:	Classroom function features stainless steel latch bolt With 3/4" (1.91cm) projection and deadlocking latch.
Cylinder:	1 3/8" (3.5cm) mortise cylinder supplied. Will accept 1 3/8" to 1 1/2" (3.5 - 3.8cm) mortise cylinder.
Cams:	Classroom function supplied with straight cam. Cams for other manufacturer's cylinder are available. See 'Mortise Lock accessories' for part numbers & manufacturers.



ALL DL6500 MORTISE LOCKS ARE WEATHER-RESISTANT

PLEASE CHECK WITH FACTORY ON LEAD TIMES FOR SPECIAL FINISHES

PRODUCT	FINISH	LIST PRICE
DL6500CRR		
Straight lever classroom function	26D	\$1,586.00
Right hand	10B	\$1,658.00
DL6500CRL		
Straight lever classroom function	26D	\$1,586.00
Left Hand	10B	\$1,658.00
DL6575CRR		
Regal (curved) lever classroom	26D	\$1,601.00
Function right hand	10B	\$1,673.00
DL6575CRL		
Regal (curved) lever classroom	26D	\$1,601.00
Function left hand	10B	\$1,673.00

Networkx training options available. See page 45 for details.



Price Book 2019

TRILOGY NETWORKX ELECTRONIC DIGITAL MORTISE LOCKS (con't)

AL-IME2	Ethernet connected gateway w/AC adapter to plug into standard wall outlet. Version 2 - allow use of expander	\$475.00
AL-IM2-80211	Wi-Fi gateway to connect to 802.11 network w/AC adapter to plug into standard wall outlet. Version 2 - allow use of expander	\$675.00
AL-IME2-POE	Power Over Ethernet, plus hardwire gateway interface capability. No AC Power required. Version 2 - allow use of expander	\$575.00
AL-IME2-EXP	Wireless expander designed to expand the coverage area of version 2 gateways. AC power required. Up to 7 expanders per version 2 gateway	\$250.00
AL-IME2-PIE	Plug-in wireless expander expands the coverage area of ver 2 gateways. Plugs into standard AC outlet. Up to 7 expanders per ver 2 gateway.	\$250.00
AL-PRE2	Prox Card Enroller - HID and iClass	\$590.00
ALID1326	Proximity Access Cards 100 Per Box	\$505.00
ALHID1336	Proximity, Magnetic Stripe and Photo ID cards 100 per box	\$1,030.00
ALHID1386	Proximity and Photo ID Card 100 per box	\$927.00
ALHID1391	MicroProx Tag 10 per box	\$82.00
ALHID1346	Proximity keyfob 10 per box	\$118.00
S6196	Networkx Replacement Battery Pack	\$45.00
AL-IME-USB	USB Gateway	\$300.00
AL-NSM	Networkx Signal Meter	\$296.00
AL-NSG	Networkx Signal Generator	\$240.00

MORTISE LOCK PARTS

CLASSROOM FUNCTION CAMS	DESCRIPTION	LIST PRICE
HW956-L	Alarm Lock Standard Straight Cam	\$5.00
HW956-M	Marks Straight Cam	\$5.00
HW956-C	Corbin-Russwin Straight Cam	\$5.00
HW956-S	Schlage Straight Cam	\$5.00
HW956-A	Arrow Straight Cam	\$5.00
HW956-R	Sargent Straight Cam	\$5.00
S6175	Replacement lever support spring	\$5.00
S6192	Lever and spring upgrade kit Standard lever – 26D, 10B	\$54.00
S6193	Lever and spring upgrade kit Regal lever – 26D, 10B	\$80.00
HW870CRL	Left Hand Classroom lock body	\$171.00
HW875CRR	Right hand Classroom lock body	\$171.00
S6196	Networkx Replacement Battery Pack	\$45.00

Networkx training options available. See page 45 for details.



Price Book 2019

TRILOGY NETWORKX ELECTRONIC PROXIMITY DIGITAL MORTISE LOCKS

PDL6500/PL6500/PDL6600 – Prox and Digital mortise lock supporting 5,000 PIN user codes (3-6 digits) and HID Proximity cards. 500 scheduled events and 35,000 event audit log.

SPECIFICATIONS:

Door Thickness:	Fits 1 5/8" to 1 7/8"
Backset:	2 3/4" standard
Strike:	1 1/4" x 4 7/8" strike included
Handing:	Specify RH or LH when ordering. Lock is reversible in the field.
Power:	4 C-Cell batteries (included)
Keypad:	All metal, 12 button. Basic functions programmed through keypad
Door Prep:	Standard ANSI A115 mortise prep, modified by adding additional through-bolt holes
Compliances:	Steelcase lock body meets BHMA specifications for Grade 1 locks UL Listed 10C Positive Pressure Specification. FCC Certified ADA compliant levers
Functions:	Classroom function features stainless steel latch bolt With 3/4" (1.91cm) projection and deadlocking latch.
Cylinder:	1 3/8" (3.5cm) mortise cylinder supplied. Will accept 1 3/8" to 1 1/2" (3.5 - 3.8cm) mortise cylinder.
Cams:	Classroom function supplied with straight cam. Cams for other manufacturer's cylinder are available. See 'Mortise Lock accessories' for part numbers & manufacturers.



***Note:**
PDL6600 - Request to exit (REX); real time when integrated with CIC, Lenel, Stanley B.A.S.I.S. When used on Networkx; sound at door, will record on audit trail. Must pull audit log to view.

**ALL PDL6500 MORTISE LOCKS ARE WEATHER-RESISTANT
PLEASE CHECK WITH FACTORY ON LEAD TIMES FOR SPECIAL FINISHES**

PRODUCT	FINISH	LIST PRICE
PDL6500CR (L) or (R) Straight lever classroom function Specify left or Right Handing	26D 10B	\$1,951.00 \$2,018.00
PDL6600CR (L) or (R) Straight lever classroom function Specify left or Right Handing w/door position switch	26D 10B	\$2,003.00 \$2,070.00
PDL6575CRR Regal (curved) lever classroom Function right hand	26D 10B	\$1,967.00 \$2,034.00
PDL6575CRL Regal (curved) lever classroom Function left hand	26D 10B	\$1,967.00 \$2,034.00
PL6500CRR (prox only) Straight lever classroom function Right hand	26D 10B	\$1,951.00 \$2,018.00
PL6500CRL (prox only) Straight lever classroom function Left Hand	26D 10B	\$1,951.00 \$2,018.00
PL6575CRR (prox only) Regal (curved) lever classroom Function right hand	26D 10B	\$1,967.00 \$2,034.00
PL6575CRL (prox only) Regal (curved) lever classroom Function left hand	26D 10B	\$1,967.00 \$2,034.00



Price Book 2019

TRILOGY NETWORKX ELECTRONIC DIGITAL MORTISE LOCKS (con't)

AL-IME2	Ethernet connected gateway w/AC adapter to plug into standard wall outlet. Version 2 - allow use of expander	\$475.00
AL-IM2-80211	Wi-Fi gateway to connect to 802.11 network w/AC adapter to plug into standard wall outlet. Version 2 - allow use of expander	\$675.00
AL-IME2-POE	Power Over Ethernet, plus hardwire gateway interface capability. No AC Power required. Version 2 - allow use of expander	\$575.00
AL-IME2-EXP	Wireless expander designed to expand the coverage area of version 2 gateways. AC power required. Up to 7 expanders per version 2 gateway	\$250.00
AL-IME2-PIE	Plug-in wireless expander expands the coverage area of ver 2 gateways. Plugs into standard AC outlet. Up to 7 expanders per ver 2 gateway.	\$250.00
AL-PRE2	Prox Card Enroller - HID and iClass	\$590.00
ALID1326	Proximity Access Cards 100 Per Box	\$505.00
ALHID1336	Proximity, Magnetic Stripe and Photo ID cards 100 per box	\$1,030.00
ALHID1386	Proximity and Photo ID Card 100 per box	\$927.00
ALHID1391	MicroProx Tag 10 per box	\$82.00
ALHID1346	Proximity keyfob 10 per box	\$118.00
S6196	Networkx Replacement Battery Pack	\$45.00
AL-IME-USB	USB Gateway	\$300.00
AL-NSM	Networkx Signal Meter	\$296.00
AL-NSG	Networkx Signal Generator	\$240.00

MORTISE LOCK PARTS

CLASSROOM FUNCTION CAMS	DESCRIPTION	LIST PRICE
HW956-L	Alarm Lock Standard Straight Cam	\$5.00
HW956-M	Marks Straight Cam	\$5.00
HW956-C	Corbin-Russwin Straight Cam	\$5.00
HW956-S	Schlage Straight Cam	\$5.00
HW956-A	Arrow Straight Cam	\$5.00
HW956-R	Sargent Straight Cam	\$5.00
S6175	Replacement lever support spring	\$5.00
S6192	Lever and spring upgrade kit Standard lever – 26D, 10B	\$54.00
S6193	Lever and spring upgrade kit Regal lever – 26D, 10B	\$80.00
HW870CRL	Left Hand Classroom lock body	\$171.00
HW875CRR	Right hand Classroom lock body	\$171.00
S6196	Networkx Replacement Battery Pack	\$45.00

Networkx training options available. See page 45 for details.

Price Book 2019

TRILOGY NETWORKX iCLASS w/REX & DPS PROXIMITY DIGITAL LOCKS

PDL8200 SERIES — Prox and digital cylindrical lock supporting 5,000 PIN user codes (3-6 digits), and a 13.56 MHz iClass smart card proximity reader. 500 scheduled events and 35,000 event audit log.

SPECIFICATIONS:



Door Thickness: Fits 1 5/8" to 1 7/8". Other thickness, refer to chart to the right.
Backset: 2 3/4" (2 3/8" also available. Must specify when ordering)
Strike: 1 1/8" x 2 3/4" T strike & 1 1/4" x 4 7/8" ASA strike included
Latch bolt: UL Listed, fire rated 3 hours, 1/2" throw, reversible
Handing: Non-handed
Power: 4 C-cell batteries (included)
Keypad: All metal, 12 button. Basic functions programmed through keypad
Door Prep: Standard ANSI A115 Series prep, modified by adding additional through-bolt holes
Compliances: BHMA Certified Grade 1 heavy duty cylindrical lockset
 UL Listed 10C Positive Pressure Specification. FCC Certified ADA compliant levers
Cylinder: 6 pin solid brass. SCY1 keyway furnished with all key override locks
 Schlage, Corbin-Russwin CL, Sargent 480 series, ASSA 65-611 & Lori cylinders can be used with the HW620 tailpiece (supplied)
Interchangeable Core Models: Standard model accepts 6 & 7 pin cylinders from Best, Falcon, Arrow, KSP, Medeco Keymark & Kaba Peaks.
 IC core models prepped for 6 & 7 pin Yale and Corbin-Russwin
 IC core models prepped for 6 pin Medeco, Sargent, and Schlage

Extended sizes:
 Standard and SFIC cylinder preps can be extended for thicker doors.
\$165.00 add on to list for extended lock.
 Extended lock legend:
 W54 - 2 1/8"
 W57 - 2 1/4"
 W60 - 2 3/8"
 W64 - 2 1/2"
 W70 - 2 3/4"
 W76 - 3"
 W83 - 3 1/4"
 W89 - 3 1/2"
 Note: Locks can be adjusted by +/- 1/8" by adding or removing spacers.

*Note:
 Request to exit (REX); real time when integrated with CIC, Lenel, Stanley B.A.S.I.S. When used on Networkx; sound at door, will record on audit trail. Must pull audit log to view.

ALL NETWORK LOCKS ARE WEATHER RESISTANT

PLEASE CHECK WITH FACTORY FOR LEAD TIMES ON SPECIAL FINISHES AND IC PREPS

PRODUCT	FINISH	LIST PRICE
PDL8200 Standard key override	26D 10B	\$2,018.00 \$2,090.00
PDL8275 Standard Key override Regal (curved)	26D 10B	\$2,044.00 \$2,106.00
PDL8200IC* Interchangeable core	26D 10B	\$2,034.00 \$2,101.00
PDL8275IC* Interchangeable core Regal (curved)	26D 10B	\$2,054.00 \$2,116.00
AL-IME2	Ethernet connected gateway w/AC adapter to plug into standard wall outlet. Version 2 - allow use of expander	\$475.00
AL-IM2-80211	Wi-Fi gateway to connect to 802.11 network w/AC adapter to plug into standard wall outlet. Version 2 - allow use of expander	\$675.00
AL-IME2-POE	Power Over Ethernet, plus hardware gateway interface capability. No AC Power required. Version 2 - allow use of expander	\$575.00
AL-IME2-EXP	Wireless expander designed to expand the coverage area of version 2 gateways. AC power required. Up to 7 expanders per version 2 gateway	\$250.00
AL-IME2-PIE	Plug-in wireless expander expands the coverage area of ver 2 gateways. Plugs into standard AC outlet. Up to 7 expanders per ver 2 gateway.	\$250.00
AL-PRE2	Prox Card Enroller - HID and iClass	\$590.00
ALID1326	Proximity Access Cards 100 Per Box	\$505.00
ALHID1336	Proximity, Magnetic Stripe and Photo ID cards 100 per box	\$1,030.00
ALHID1386	Proximity and Photo ID Card 100 per box	\$927.00
ALHID1391	MicroProx Tag 10 per box	\$82.00
ALHID1346	Proximity keyfob 10 per box	\$118.00
S6196	Networkx Replacement Battery Pack	\$45.00
AL-IME-USB	USB Gateway	\$300.00
AL-NSM	Networkx Signal Meter	\$296.00
AL-NSG	Networkx Signal Generator	\$240.00

*Add "C" for Corbin, "M" for Medeco, "R" for Sargent, "Y" for Yale and "S" for Schlage to end of the part number for specially prepped IC core models. Add \$15.00 to the list price shown above. **MUST SPECIFY 7 PIN FOR CORBIN AND YALE** For small format Medeco IC, specify SFIC prep.



Price Book 2019

TRILOGY NETWORKX ELECTRONIC iCLASS PROXIMITY DIGITAL MORTISE LOCKS w/REX & DPS

PDL8600 – iClass Prox and Digital mortise lock supporting 5,000 PIN user codes (3-6 digits) with a 13.56 MHz iClass smart card proximity reader. 500 scheduled events and 35,000 event audit log.

SPECIFICATIONS:

***Note:**
Request to exit (REX); real time when integrated with CIC, Lenel, Stanley B.A.S.I.S. When used on Networkx; sound at door, will record on audit trail. Must pull audit log to view.

Door Thickness:	Fits 1 5/8" to 1 7/8"
Backset:	2 3/4" standard
Strike:	1 1/4" x 4 7/8" strike included
Handing:	Specify RH or LH when ordering. Lock is reversible in the field.
Power:	4 C-Cell batteries (included)
Keypad:	All metal, 12 button. Basic functions programmed through keypad
Door Prep:	Standard ANSI A115 mortise prep, modified by adding additional through-bolt holes
Compliances:	Steelcase lock body meets BHMA specifications for Grade 1 locks UL Listed 10C Positive Pressure Specification. FCC Certified ADA compliant levers
Functions:	Classroom function features stainless steel latch bolt With 3/4" (1.91cm) projection and deadlocking latch.
Cylinder:	1 3/8" (3.5cm) mortise cylinder supplied. Will accept 1 3/8" to 1 1/2" (3.5 - 3.8cm) mortise cylinder.
Cams:	Classroom function supplied with straight cam. Cams for other manufacturer's cylinder are available. See 'Mortise Lock accessories' for part numbers & manufacturers.



**ALL PDL8600 MORTISE LOCKS ARE WEATHER-RESISTANT
PLEASE CHECK WITH FACTORY ON LEAD TIMES FOR SPECIAL FINISHES**

PRODUCT	FINISH	LIST PRICE
PDL8600CRR		
Straight lever classroom function	26D	\$2,106.00
Right Hand	10B	\$2,173.00
PDL8600CRL		
Straight lever classroom function	26D	\$2,106.00
Left Hand	10B	\$2,173.00
PDL8675CRR		
Regal (curved) lever classroom	26D	\$2,121.00
Function right hand	10B	\$2,188.00
PDL8675CRL		
Regal (curved) lever classroom	26D	\$2,121.00
Function left hand	10B	\$2,188.00
PL8600CRR (prox only)		
Straight lever classroom function	26D	\$2,106.00
Right hand	10B	\$2,173.00
PL8600CRL (prox only)		
Straight lever classroom function	26D	\$2,106.00
Left Hand	10B	\$2,173.00
PL8675CRR (prox only)		
Regal (curved) lever classroom	26D	\$2,121.00
Function right hand	10B	\$2,188.00
PL8675CRL (prox only)		
Regal (curved) lever classroom	26D	\$2,121.00
Function left hand	10B	\$2,188.00



Price Book 2019

TRILOGY NETWORKX ELECTRONIC DIGITAL MORTISE LOCKS (con't)

AL-IME2	Ethernet connected gateway w/AC adapter to plug into standard wall outlet. Version 2 - allow use of expander	\$475.00
AL-IM2-80211	Wi-Fi gateway to connect to 802.11 network w/AC adapter to plug into standard wall outlet. Version 2 - allow use of expander	\$675.00
AL-IME2-POE	Power Over Ethernet, plus hardwire gateway interface capability. No AC Power required. Version 2 - allow use of expander	\$575.00
AL-IME2-EXP	Wireless expander designed to expand the coverage area of version 2 gateways. AC power required. Up to 7 expanders per version 2 gateway	\$250.00
AL-IME2-PIE	Plug-in wireless expander expands the coverage area of ver 2 gateways. Plugs into standard AC outlet. Up to 7 expanders per ver 2 gateway.	\$250.00
AL-PRE2	Prox Card Enroller - HID and iClass	\$590.00
ALID1326	Proximity Access Cards 100 Per Box	\$505.00
ALHID1336	Proximity, Magnetic Stripe and Photo ID cards 100 per box	\$1,030.00
ALHID1386	Proximity and Photo ID Card 100 per box	\$927.00
ALHID1391	MicroProx Tag 10 per box	\$82.00
ALHID1346	Proximity keyfob 10 per box	\$118.00
S6196	Networx Replacement Battery Pack	\$45.00
AL-IME-USB	USB Gateway	\$300.00
AL-NSM	Networx Signal Meter	\$296.00
AL-NSG	Networx Signal Generator	\$240.00

MORTISE LOCK PARTS

CLASSROOM FUNCTION CAMS	DESCRIPTION	LIST PRICE
HW956-L	Alarm Lock Standard Straight Cam	\$5.00
HW956-M	Marks Straight Cam	\$5.00
HW956-C	Corbin-Russwin Straight Cam	\$5.00
HW956-S	Schlage Straight Cam	\$5.00
HW956-A	Arrow Straight Cam	\$5.00
HW956-R	Sargent Straight Cam	\$5.00
S6175	Replacement lever support spring	\$5.00
S6192	Lever and spring upgrade kit Standard lever – 26D, 10B	\$54.00
S6193	Lever and spring upgrade kit Regal lever – 26D, 10B	\$80.00
HW870CRL	Left Hand Classroom lock body	\$171.00
HW875CRR	Right hand Classroom lock body	\$171.00
S6196	Networx Replacement Battery Pack	\$45.00

Networx training options available. See page 45 for details.

Price Book 2019
NETWORX DOUBLE SIDED PROX/DIGITAL LOCKS

DL/PDL6300 Double sided prox and/or digital cylindrical lock supporting 5,000 PIN user codes (3-6 digits), and/or HID proximity cards. 500 scheduled events and 35,000 event audit log.

SPECIFICATIONS:

DL6300

PDL6300

Door Thickness:	Fits 1 5/8" to 1 7/8".
Backset:	2 3/4" (2 3/8" also available. Must specify when ordering)
Strike:	1 1/8" x 2 3/4" T strike & 1 1/4" x 4 7/8" ASA strike included
Latch bolt:	UL Listed, fire rated 3 hours, 1/2" throw, reversible
Handing:	Non-handed
Power:	4 AA alkaline batteries (included)
Keypad:	All metal, 12 button. Basic functions programmed through keypad
Door Prep:	Standard ANSI A115 Series prep, modified by adding additional through-bolt holes
Compliances:	BHMA Certified Grade 1 heavy duty cylindrical lockset UL Listed 10C Positive Pressure Specification. FCC Certified ADA compliant levers
Cylinder:	6 pin solid brass. SCY1 keyway furnished with all key override locks Schlage, Corbin-Russwin CL, Sargent 480 series, ASSA 65-611 & Lori cylinders can be used with the HW620 tailpiece (supplied)
Interchangeable Core Models:	Standard model accepts 6 & 7 pin cylinders from Best, Falcon, Arrow only

**ALL NETWORX LOCKS ARE WEATHER-RESISTANT PLEASE CHECK WITH
FACTORY FOR LEAD TIMES ON SPECIAL FINISHES**

PRODUCT	FINISH	LIST PRICE
DL6300	US26D	\$1,624.00
Standard key override	US3 & US10B	\$1,724.00
DL6300IC	US26D	\$1,699.00
Interchangeable core	US3 & US10B	\$1,799.00
PDL6300	US26D	\$1,874.00
Interchangeable core	US3 & US10B	\$1,974.00
PDL6300IC	US26D	\$1,883.00
Interchangeable core	US3 & US10B	\$1,986.00
AL-PRE2	Prox Card Enroller - HID and iClass	\$590.00
ALID1326	Proximity Access Cards 100 Per Box	\$505.00
ALHID1336	Proximity, Magnetic Stripe and Photo ID cards 100 per box	\$1,030.00
ALHID1386	Proximity and Photo ID Card 100 per box	\$927.00
ALHID1391	MicroProx Tag 10 per box	\$82.00
ALHID1346	Proximity keyfob 10 per box	\$118.00
AL-IME-USB	USB Gateway	\$300.00
AL-NSM	Networx Signal Meter	\$296.00
AL-NSG	Networx Signal Generator	\$240.00

Note: Key override operates latch on primary side only. Key override on secondary side protects the battery pack.

Price Book 2019

TRILOGY NETWORKX GATEWAYS



AL-IME2	Ethernet connected gateway w/AC adapter to plug into standard wall outlet. Version 2 - allow use of expander	\$475.00
AL-IM2-80211	Wi-Fi gateway to connect to 802.11 network w/AC adapter to plug into standard wall outlet. Version 2 - allow use of expander	\$675.00
AL-IME2-POEP	Power Over Ethernet, plus hardwire gateway interface capability. No AC Power required. Version 2 - allow use of expander	\$575.00
AL-IME2-EXP	Wireless expander designed to expand the coverage area of version 2 gateways. AC power required. Up to 7 expanders per version 2 gateway	\$250.00
AL-IME2-PIE	Plug-in wireless expander designed to expand the coverage area of version 2 gateways. Plugs into a standard AC outlet. Up to 7 expanders per version 2 gateway	\$250.00



Price Book 2019

NETWORX NARROW STILE LOCK PRODUCTS

DL1300NW SERIES – Wireless aluminum door retrofit outside trim. Works with Adams Rite® 1850, 1950, 4710, 4070, 4730, 4900 series spring latch and MS18505 & MS19505 series deadbolts. 5,000 user codes, master, Manager, basic user and multiple “one-time” user codes. 500 event schedule, real time clock & 40,000 event audit trail.

SPECIFICATIONS:

Door Thickness:	Supports stile 1 3/4" only
Backset:	Supports 3 1/32", 1 1/8", and 1 1/2"
Handing:	Non-handed
Power:	Uses 4 AA batteries (included)
Keypad:	All metal, 12 button.
Cylinder:	Supplied with 6 pin standard mortise cylinder in SC1 keyway 1 3/8" or 1 1/2" cylinders supported
Cams:	Cam supplied works with generic Alarm Lock cylinder. Other standard cams available for Corbin-Russwin, Marks, Arrow, Sargent and Schlage. IC type cams for Best, Corbin-Russwin, Medeco, Schlage and Yale are also available.



Lockdown or Unlock with Keyfob, For use w/ DL or PDL1300NW model - Up to 10 users can be programmed for varying privileges on multiple locks/fob (Optional: #RR-4BKEYFOB)

ALL NETWORX SERIES LOCKS ARE WEATHER RESISTANT

PRODUCT	DESCRIPTION	LIST PRICE
DL1300NW/26D1	Lever set works with Adams Rite® 4500, 4700, & 4900 series deadlatch 26D finish	\$850.00
DL1300NW/10B1	Lever set works with Adams Rite® 4500, 4700, & 4900 series deadlatch 10B finish	\$850.00
DL1325NW/26D2	Thumb turn works with Adams Rite® 4070, MS18505, MS1950 series deadbolt 26D finish	\$850.00
DL1325NW/10B2	Thumb turn works with Adams Rite® 4070, MS18505, MS1950 series deadbolt 10B finish	\$850.00
DL1350NW/26D2	Knob works with Adams Rite® 4070, MS18505, MS1950 series deadbolt 26D finish	\$850.00
DL1350NW/10B2	Knob works with Adams Rite® 4070, MS18505, MS1950 series deadbolt 10B finish	\$850.00



NETWORKX NARROW STILE LOCK PRODUCTS

PDL1300NW SERIES – Wireless aluminum door retrofit outside trim. Works with Adams Rite® 1850, 1950, 4710,4070, 4730, 4900 series spring latch and MS18505 & MS19505 series deadbolts. 5,000 user codes, master, Manager, basic user and multiple “one-time” user codes. 500 event schedule, real time clock & 40,000 event audit trail.

SPECIFICATIONS:

- Door Thickness:** Supports stile 1 3/4" only
- Backset:** Supports 3 1/32", 1 1/8", and 1 1/2"
- Handing:** Non-handed
- Power:** Uses 4 AA batteries (included)
- Keypad:** All metal, 12 button.
- Cylinder:** Supplied with 6 pin standard mortise cylinder in SC1 keyway
1 3/8" or 1 1/2" cylinders supported
- Cams:** Cam supplied works with generic Alarm Lock cylinder. Other standard cams available for Corbin-Russwin, Marks, Arrow, Sargent and Schlage. IC type cams for Best, Corbin-Russwin, Medeco, Schlage and Yale are also available.



Lockdown or Unlock with Keyfob, For use w/ DL or PDL1300NW model - Up to 10 users can be programmed for varying privileges on multiple locks/fob (Optional: #RR-4BKEYFOB)

ALL NETWORKX SERIES LOCKS ARE WEATHER RESISTANT

PRODUCT	DESCRIPTION	LIST PRICE
PDL1300NW/26D1	Lever set works with Adams Rite® 4500, 4700, & 4900 series deadlatch 26D finish	\$1,211.00
PDL1300NW/10B1	Lever set works with Adams Rite® 4500, 4700, & 4900 series deadlatch 10B finish	\$1,211.00
PDL1325NW/26D2	Thumb turn works with Adams Rite® 4070, MS18505, MS1950 series deadbolt 26D finish	\$1,211.00
PDL1325NW/10B2	Thumb turn works with Adams Rite® 4070, MS18505, MS1950 series deadbolt 10B finish	\$1,211.00
PDL1350NW/26D2	Knob works with Adams Rite® 4070, MS18505, MS1950 series deadbolt 26D finish	\$1,211.00
PDL1350NW/10B2	Knob works with Adams Rite® 4070, MS18505, MS1950 series deadbolt 10B finish	\$1,211.00



NETWORKX NARROW STILE LOCK ACCESSORIES

AL-IME2	Ethernet connected gateway w/AC adapter to plug into standard wall outlet. Version 2 - allow use of expander	\$475.00
AL-IM2-80211	Wi-Fi gateway to connect to 802.11 network w/AC adapter to plug into standard wall outlet. Version 2 - allow use of expander	\$675.00
AL-IME2-POE	Power Over Ethernet, plus hardwire gateway interface capability. No AC Power required. Version 2 - allow use of expander	\$575.00
AL-IME2-EXP	Wireless expander designed to expand the coverage area of version 2 gateways. AC power required. Up to 7 expanders per version 2 gateway	\$250.00
AL-IME2-PIE	Plug-in wireless expander expands the coverage area of ver 2 gateways. Plugs into standard AC outlet. Up to 7 expanders per ver 2 gateway.	\$250.00
AL-PRE2	Prox Card Enroller - HID and iClass	\$590.00
ALID1326	Proximity Access Cards 100 Per Box	\$505.00
ALHID1336	Proximity, Magnetic Stripe and Photo ID cards 100 per box	\$1,030.00
ALHID1386	Proximity and Photo ID Card 100 per box	\$927.00
ALHID1391	MicroProx Tag 10 per box	\$82.00
ALHID1346	Proximity keyfob 10 per box	\$118.00
S6196	Networkx Replacement Battery Pack	\$45.00
AL-IME-USB	USB Gateway	\$300.00
AL-NSM	Networkx Signal Meter	\$296.00
AL-NSG	Networkx Signal Generator	\$240.00

PARTS

STANDARD MORTISE CAMS	DESCRIPTION	LIST PRICE
HW1344	Corbin-Russwin standard cam	\$5.00
HW1346	Marks standard cam	\$5.00
HW1348	Arrow & Sargent standard cams	\$5.00
HW1349	Schlage standard cam	\$5.00
IC MORTISE CAMS		
HW1345	Corbin-Russwin IC cam	\$11.00
HW1347	Medeco IC cam	\$11.00
HW1350	Schlage IC cam	\$11.00
HW1343	Best IC cam	\$11.00
S6169	Best IC housing with cam attached 26D, 10B	\$42.00

HOW TO ORDER THE NETWORKX NARROW STILE LOCKS

Last two digits of the part number are

Used with Adams Rite Product

00 Straight Lever

4500, 4700 & 4900 Series Only

25 Thumb turn

MS1850, MS1950 & 4070 Series

50 Knob

MS1850, MS1950 & 4070 Series



Price Book 2019

NETWORX NARROW STYLE/EXIT LOCK PRODUCTS

DL1300ETNW & PDL1300ETNW SERIES - Wireless aluminum door retrofit outside trim. Works with Marks, Arrow, DCI, Von Duprin, Corbin, Dor-o-matic, Dorma & Jackson. DL1300ETNW & PDL1300ETNW have 5,000 user codes, multiple "one-time" user codes. 500 event schedule, real time clock & 40,000 event audit trail. PDL1300ETNW also has proximity capabilities.

SPECIFICATIONS:



DL1300ETNW

Door Thickness:	Supports stile 1 3/4" only
Backset:	Supports 3 1/32", 1 1/8", and 1 1/2"
Handing:	Non-handed
Power:	Uses 4 AA batteries (included)
Keypad:	All metal, 12 button.
Cylinder:	Supplied with 6 pin standard mortise cylinder in SC1 keyway 1 3/8" or 1 1/2" cylinders supported
Cams:	Cam supplied works with generic Alarm Lock cylinder. Other standard cams available for Corbin-Russwin, Marks, Arrow, Sargent and Schlage. IC type cams for Best, Corbin-Russwin, Medeco, Schlage and Yale are also available.



PDL1300ETNW

Lockdown or Unlock with Keyfob, For use w/ DL or PDL1300NW model - Up to 10 users can be programmed for varying privileges on multiple locks/ fob (Optional: #RR-4BKEYFOB)

**Must order separate tailpiece for specific ET being installed
Note: ET Trim works w/V33 LH (RHR) only
ALL NARROW STILE/EXIT LOCKS ARE WEATHER-RESISTANT**

PRODUCT	DESCRIPTION	LIST PRICE
DL1300ETNW/26D STRAIGHT LEVER	Narrow Stile Lock for Arrow S1200/S1250, Marks 8800, DCI 1200/1300, Von Duprin 22, Corbin ED8200 & Von Duprin 33 panic LH (RHR) devices only	\$850.00
DL1300ETNW/10B STRAIGHT LEVER	Narrow Stile Lock for Arrow S1200/S1250, Marks 8800, DCI 1200/1300, Von Duprin 22, Corbin ED8200 & Von Duprin 33 panic LH (RHR) devices only	\$850.00
DL1325ETNW/26D TURNPIECE	Narrow Stile lock for Dor-o-Matic 2090, Jackson 1095 & Dorma 5300 panic devices	\$850.00
DL1325ETNW/10B TURNPIECE	Narrow Stile lock for Dor-o-Matic 2090, Jackson 1095 & Dorma 5300 panic devices	\$850.00
DL1350ETNW/26D KNOB	Narrow Stile lock for Dor-o-Matic 2090, Jackson 1095 & Dorma 5300 panic devices	\$850.00

NETWORK NARROW STYLE/EXIT LOCK PRODUCTS

DL1350ETNW/10B KNOB	Narrow Stile lock for Dor-o-Matic 2090, Jackson 1095 & Dorma 5300 panic devices	\$850.00
PDL1300ETNW/26D STRAIGHT LEVER	Narrow Stile Lock for Arrow S1200/S1250, Marks 8800, DCI 1200/1300, Von Duprin 22, Corbin ED8200 & Von Duprin 33 panic LH (RHR) devices only	\$1,211.00
PDL1300ETNW/10B STRIGHT LEVER	Narrow Stile Lock for Arrow S1200/S1250, Marks 8800, DCI 1200/1300, Von Duprin 22, Corbin ED8200 & Von Duprin 33 panic LH (RHR) devices only	\$1,211.00
PDL1325ETNW/26D TURNPIECE	Narrow Stile lock for Dor-o-Matic 2090, Jackson 1095 & Dorma 5300 panic devices	\$1,211.00
PDL1325ETNW/210B TURNPIECE	Narrow Stile lock for Dor-o-Matic 2090, Jackson 1095 & Dorma 5300 panic devices	\$1,211.00
PDL1350ETNW/26D KNOB	Narrow Stile lock for Dor-o-Matic 2090, Jackson 1095 & Dorma 5300 panic devices	\$1,211.00
PDL1350ETNW/10B KNOB	Narrow Stile lock for Dor-o-Matic 2090, Jackson 1095 & Dorma 5300 panic devices	\$1,211.00

Tailpieces must be used with the Panic Devices as shown below

TAILPIECE PART NUMBER	PANIC DEVICE	LIST PRICE
TP-1691	Used with Arrow S1200/1250, DCI 1200/1300, Von Duprin 22 & Dorma 5300, Marks 8800 Panic Devices	\$57.00
TP-1692	Used with Dor-o-Matic 2090 Panic Device	\$57.00
TP-1693	Used with Corbin ED8200 Panic Device	\$57.00
TP-1694	Used with Von Duprin 33 LH (RHR) devices only	\$57.00
TP-1698	Used with Jackson 1095 Panic Device	\$57.00

NETWORK NARROW STYLE/EXIT LOCK ACCESSORIES

AL-IME2	Ethernet connected gateway w/AC adapter to plug into standard wall outlet. Version 2 - allow use of expander	\$475.00
AL-IM2-80211	Wi-Fi gateway to connect to 802.11 network w/AC adapter to plug into standard wall outlet. Version 2 - allow use of expander	\$675.00
AL-IME2-POE	Power Over Ethernet, plus hardwire gateway interface capability. No AC Power required. Version 2 - allow use of expander	\$575.00
AL-IME2-EXP	Wireless expander designed to expand the coverage area of version 2 gateways. AC power required. Up to 7 expanders per version 2 gateway	\$250.00
AL-IME2-PIE	Plug-in wireless expander expands the coverage area of ver 2 gateways. Plugs into standard AC outlet. Up to 7 expanders per ver 2 gateway.	\$250.00
AL-PRE2	Prox Card Enroller - HID and iClass	\$590.00
ALID1326	Proximity Access Cards 100 Per Box	\$505.00
ALHID1336	Proximity, Magnetic Stripe and Photo ID cards 100 per box	\$1,030.00
ALHID1386	Proximity and Photo ID Card 100 per box	\$927.00
ALHID1391	MicroProx Tag 10 per box	\$82.00
ALHID1346	Proximity keyfob 10 per box	\$118.00
S6196	Networkx Replacement Battery Pack	\$45.00
AL-IME-USB	USB Gateway	\$300.00
AL-NSM	Networkx Signal Meter	\$296.00
AL-NSG	Networkx Signal Generator	\$240.00

PARTS

STANDARD MORTISE CAMS	DESCRIPTION	LIST PRICE
HW1344	Corbin-Russwin standard cam	\$5.00
HW1346	Marks standard cam	\$5.00
HW1348	Arrow & Sargent standard cams	\$5.00
HW1349	Schlage standard cam	\$5.00
IC MORTISE CAMS		
HW1345	Corbin-Russwin IC cam	\$11.00
HW1347	Medeco IC cam	\$11.00
HW1350	Schlage IC cam	\$11.00
HW1343	Best IC cam	\$11.00
S6169	Best IC housing with cam attached 26D, 10B	\$42.00

Price Book 2019

TRILOGY NETWORKX EXIT TRIM PRODUCTS

Battery operated Trilogy outside trim works with Marks M9900, Von Duprin 99, Corbin ED5000, Yale 7100, Dorma 9300, Arrow 3800, Sargent 8888, Precision 1100, 2100 & Cal Royal 9800, Hager 4500 series panic devices. Available in DL series (keypad) or PDL (prox/keypad) formats. Features include 5,000 user codes, 500 scheduled events and 35,000 event audit log.

SPECIFICATIONS:

Door Thickness:	Standard model fits 1 5/8" to 1 7/8"
Handing:	Non-handed
Power:	4 C-cell batteries (included) mounted on the inside of door
Keypad:	Weather-resistant all metal, 12 button. Basic functions programmed through keypad. PDL version proximity antenna housing molded of ultra strength, impact resistant Lexan®
Cylinder:	Use standard rim cylinder to operate key override function. Will accept 6 or 7 pin interchangeable core cylinders (see below).



ALL ET SERIES LOCKS ARE WEATHER-RESISTANT
PLEASE CHECK WITH FACTORY FOR LEAD TIMES ON SPECIAL FINISHES

PRODUCT	DESCRIPTION	LIST PRICE
ETDLN series	26D Finish	\$1,426.00
ETDLN series	10B Finish	\$1,493.00
ETDLN series w/Regal lever	26D Finish	\$1,447.00
ETDLN series w/Regal lever	10B Finish	\$1,503.00
ETPDN series	26D Finish	\$1,766.00
ETPDN series	10B Finish	\$1,828.00
ETPDN series w/Regal lever	26D Finish	\$1,781.00
ETPDN series w/Regal lever	10B Finish	\$1,843.00
ETPDNSRX w/REX and DPS	26D Finish	\$1,817.00
ETPDNISRX iClass w/REX and DPS	26D Finish	\$1,917.00
	26D Finish	\$1,766.00
ETPLN series	10B Finish	\$1,828.00
	26D Finish	\$1,781.00
ETPLN series w/Regal lever	10B Finish	\$1,843.00
Specify finish on adapter kit ET- AL Finish = 26D & US10B	Alarm Lock Standard Rim Cylinder Adapter kit (Schlage C keyway)	\$57.00
ET- AR Finish = 26D & US10B	Arrow Standard Rim Cylinder Adapter kit	\$57.00
ET- AS Finish = 26D & US10B	ASSA Standard Rim Cylinder Adapter kit	\$57.00
ET - C Finish = 26D & US10B	Corbin Standard Rim Cylinder Adapter kit	\$57.00
ET - M Finish = 26D & US10B	Medeco Standard Rim Cylinder Adapter kit	\$57.00
ET - R Finish = 26D & US10B	Sargent Standard Rim Cylinder Adapter kit	\$57.00
ET - S Finish = 26D & US10B	Schlage Standard Rim Cylinder Adapter kit	\$57.00
ET - Y Finish = 26D & US10B	Yale Standard Rim Cylinder Adapter kit	\$57.00
ET - ARIC Finish = 26D & 10B	Arrow IC 6 & 7 Pin Rim Cylinder Adapter kit	\$79.00
ET - BIC Finish = 26D & US10B	Best IC 6 & 7 Pin Rim Cylinder Adapter kit	\$79.00
ET - CIC Finish = 26D & US10B	Corbin IC Rim Cylinder Adapter kit	\$79.00
ET - MIC Finish = 26D & US10B	Medeco IC 6 & 7 Pin Rim Cylinder Adapter kit	\$79.00



Price Book 2019

TRILOGY NETWOX EXIT TRIM PRODUCTS (CONT'D)

Product	Description	LIST PRICE
ET - RIC Finish = 26D, 10B	Sargent IC Rim Cylinder Adapter kit	\$79.00
ET - SIC Finish = 26D, 10B	Schlage IC Rim Cylinder Adapter kit	\$79.00
ET - YIC Finish = 26D, 10B	Yale IC 6 Pin Rim Cylinder Adapter kit	\$79.00
AL-IME2	Ethernet connected gateway w/AC adapter to plug into standard wall outlet. Version 2 - allow use of expander	\$475.00
AL-IM2-80211	Wi-Fi gateway to connect to 802.11 network w/AC adapter to plug into standard wall outlet. Version 2 - allow use of expander	\$675.00
AL-IME2-POE	Power Over Ethernet, plus hardwire gateway interface capability. No AC Power required. Version 2 - allow use of expander	\$575.00
AL-IME2-EXP	Wireless expander designed to expand the coverage area of version 2 gateways. AC power required. Up to 7 expanders per version 2 gateway	\$250.00
AL-IME2-PIE	Plug-in wireless expander expands the coverage area of ver 2 gateways. Plugs into standard AC outlet. Up to 7 expanders per ver 2 gateway.	\$250.00
AL-PRE2	Prox Card Enroller - HID and iClass	\$590.00
ALID1326	Proximity Access Cards 100 Per Box	\$505.00
ALHID1336	Proximity, Magnetic Stripe and Photo ID cards 100 per box	\$1,030.00
ALHID1386	Proximity and Photo ID Card 100 per box	\$927.00
ALHID1391	MicroProx Tag 10 per box	\$82.00
ALHID1346	Proximity keyfob 10 per box	\$118.00
S6196	Networx Replacement Battery Pack	\$45.00
AL-IME-USB	USB Gateway	\$300.00
AL-NSM	Networx Signal Meter	\$296.00
AL-NSG	Networx Signal Generator	\$240.00

NETWORX EXIT TRIM KITS W/MARKS M9900 PANIC BAR

PRODUCT	DESCRIPTION	LIST PRICE
ETDLN-M99K	26D Finish	\$1,850.00
ETPDN-M99K	26D Finish	\$2,190.00

TRILOGY EXIT TRIM PRODUCTS PARTS
EXTENDED SPINDLES MUST BE PURCHASED SEPARATELY

S6146 Extended Spindle and screws	Extend exit trim to fit 2 – 2 ¾” doors	\$112.00
S6147 Extended Spindle and screws	Extend exit trim to fit 3 – 4” doors	\$112.00
S6195 Extended Spindle and screws	Extend exit trim to fit 4 ¼ - 5” doors	\$112.00
SC544	Extended replacement screws with adjustable lengths (4 per unit)	\$21.00 each

PLEASE SEE “HOW TO ORDER” CHART ON NEXT PAGE TO PROPERLY ORDER YOUR TRILOGY EXIT TRIM.

IF YOU REQUIRE THE LOCK TO BE PREPPED FOR A THICKER DOOR, YOU MUST ORDER BASED ON THE SELECTIONS SHOWN. THE BASIC MODEL IS PREPPED FOR A 1 5/8” TO 1 7/8” DOOR.

****** PRECISION 2100 SERIES WILL WORK WITH THE VON DUPRIN 99 PREP. YOU MUST GET A MOUNTING PLATE PART # BP21 FROM PRECISION******

HOW TO ORDER YOUR TRILOGY NETWORKX EXIT LOCK

Below is a “How to Order” guide for the Trilogy Exit Trim products. Please follow this guide when placing orders to avoid any delay in processing your order.

All units are sold with a generic cylinder adapter installed. When you are using a specific brand of rim cylinder, you must purchase a Cylinder Adapter Kit from the chart below.

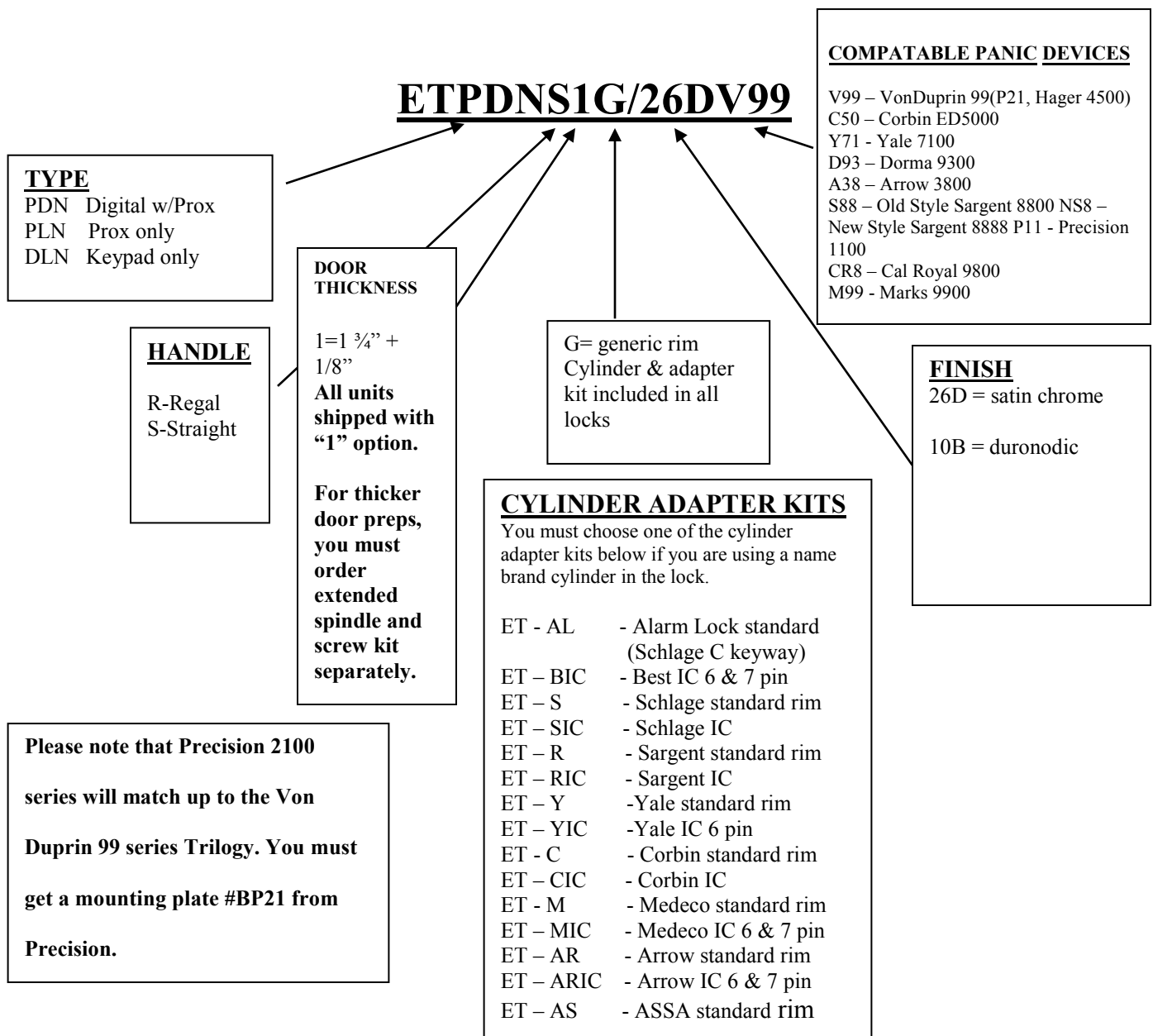



Price Book 2019

TRILOGY NETWORKX WIRELESS KEYPADS AND NETPANEL

Trilogy Networkx Wireless Keypads and Netpanel combine to provide the ideal wireless keypad solution for use with mag locks, strikes and electrified exit devices in a smart access system with advanced features and functions, like automatic schedules, event logs and supports for 2000 doors and 5000 existing Prox ID Cards/Badges.

SPECIFICATIONS:

Networkx Keypads NETDK / NETPDK

- Power Requirements: 12VDC supplied by NETWORKXPANEL
- Idle Current: 10mA
- Maximum Wire Length: 200 feet (61m)
- Proximity Card Formats Supported: Alarm Lock
- standard 36 bit format or HID standard 26 bit format (for use with the model NETPDK only)

Networkx Panel NETWORKXPANEL

- Input Power: 16.5VAC via Class 2 Plug-In 50VA Transformer (supplied model TRF-14)
- Maximum Lock Power Output Current: 1.5A @12VDC
- Maximum Wiegand Power Output Current: 250mA @ 12VDC
- Maximum Wiegand Red and Green LED Current: 20mA each output
- Maximum Sounder Current: 100mA
- Maximum Keypad Power Output Current: 200mA@ 12VDC
- Primary and Secondary Relays: SPDT Form C, N/O, N/C 8A @ 30VAC or VDC
- Supplied Backup Battery: Sealed Lead Acid 4AH
- Battery Backup Time: Approximately 2 hours at full load



Note: In order for NETDK OR NETPDK to operate you MUST include a NETWORKXPANEL

ALL NETDK/PDK KEYPADS ARE WEATHER RESISTANT

PRODUCT	FINISH	LIST PRICE
NETDK Digital wireless keypad only	26D, 10B	\$309.00
NETPDK Digital & Prox wireless keypad only	26D, 10B	\$633.00
NETDKPAK Digital wireless wall mounted keypad kit, includes wall mounted reader, control panel w/door position switch with RX, remote release, battery backup and plug in transformer.	26D, 10B	\$1,050.00
NETPDKPAK Digital & HID wireless wall mounted keypad kit, includes wall mounted reader, control panel w/door position switch with RX, remote release, battery backup and plug in transformer.	26D, 10B	\$1,375.00



Price Book 2019

TRILOGY NETWORX WIRELESS KEYPADS AND NETPANEL (con't)

NETWORXPANEL	NETWORX wireless control panel only, used with Networx NETDK and NETPDK readers and approved wiegand input readers.	\$741.00
NETHIDNSPAK Networx Narrow Stile Pak	HID Narrow Stile Prox point reader, control panel w/door position switch with RX, remote release, and battery backup and plug in transformer.	\$957.00
NETHIDNS Networx Narrow Stile Reader	HID Narrow Stile Prox Point Reader Only	\$157.00
AL-IME2	Ethernet connected gateway w/AC adapter to plug into standard wall outlet. Version 2 - allow use of expander	\$475.00
AL-IM2-80211	Wi-Fi gateway to connect to 802.11 network w/AC adapter to plug into standard wall outlet. Version 2 - allow use of expander	\$675.00
AL-IME2-POE	Power Over Ethernet, plus hardwire gateway interface capability. No AC Power required. Version 2 - allow use of expander	\$575.00
AL-IME2-EXP	Wireless expander designed to expand the coverage area of version 2 gateways. AC power required. Up to 7 expanders per version 2 gateway	\$250.00
AL-IME2-PIE	Plug-in wireless expander expands the coverage area of ver 2 gateways. Plugs into standard AC outlet. Up to 7 expanders per ver 2 gateway.	\$250.00
AL-PRE2	Prox Card Enroller - HID and iClass	\$590.00
ALID1326	Proximity Access Cards 100 Per Box	\$505.00
ALHID1336	Proximity, Magnetic Stripe and Photo ID cards 100 per box	\$1,030.00
ALHID1386	Proximity and Photo ID Card 100 per box	\$927.00
ALHID1391	MicroProx Tag 10 per box	\$82.00
ALHID1346	Proximity keyfob 10 per box	\$118.00
S6196	Networx Replacement Battery Pack	\$45.00
AL-IME-USB	USB Gateway	\$300.00
AL-NSM	Networx Signal Meter	\$296.00
AL-NSG	Networx Signal Generator	\$240.00
BT102	Networx Panel Replacement Battery	\$55.00
S6187	Replacement ET Networx Radio	\$185.00
S6185 (specify finish)	Replacement Inside Housing for DL/PDL6100 (includes radio)	\$288.00

Networx training options available. See page 45 for details.

Price Book 2019

TRILOGY & NETWORX REMOTE RELEASE PRODUCTS



PRODUCT	DESCRIPTION	LIST PRICE
RR-TRILOGYKIT	Remote release kit for all Trilogy Cylindrical models includes the RR-1BUTTON for desk mount applications and RR-RECEIVER which is designed to be installed inside the battery compartment next to the battery pack of any cylindrical Trilogy lock. The RR-RECEIVER connects to the 2 white remote release wires inside the battery compartment and to the black and red battery pack wires to power the receiver. These kits will retro fit to any existing cylindrical Trilogy manufactured since 1994.	\$221.00
RR-RECEIVER	RR-RECEIVER is designed to be installed next to the battery pack of any cylindrical Trilogy lock. The RR-RECEIVER connects to the 2 white remote release wires and to the black and red battery pack wires and will retro fit to any existing cylindrical Trilogy manufactured since 1994. You will need to purchase separately either an RR-1BUTTON OR 4BKEYFOB to activate the receiver	\$128.00
RR-1BUTTON	Remote release desk mounted button designed to be used with any existing Networx lock enrolled with a simple keypad program. Must update the firmware of your existing Networx Lock. Also can be used with an RR-RECEIVER to any existing Trilogy Cylindrical Lock, RR-RECEIVER sold separately.	\$92.00
RR-4BKEYFOB	Remote release 4 button key fob designed to be used with any existing Networx lock enrolled with a simple keypad program. Must update the firmware of your existing Networx Lock. Also can be used with an RR-RECEIVER to any existing Trilogy Cylindrical Lock, RR-RECEIVER sold separately.	\$103.00
RR-MORTISEKIT RR-EXITTRIMKIT	Remote release kit for Mortise Locks Remote release kit for Exit Trim Locks *Both include RR-1BUTTON and RECEIVER mounted on a Lexan battery cover.*	\$242.00 \$242.00

Note: The Remote Release Products follow the Networx Discount Structure. Will not work with non-Networx Narrow Stile series lock sets.



Price Book 2019

TRILOGY NETWORX UPGRADE KITS

PRODUCT	DESCRIPTION	LIST PRICE
DL610026DUPGRD	Component kit to upgrade a standard Trilogy cylindrical model to a DL6100 Networx model. Kit includes a Networx outside digital keypad housing, inside housing with radio and a battery pack. Upgrade kit is designed to replace the existing and install in place same components, reusing the existing levers, cylinder, lock body & strike plate. Used with a Networx gateway purchased separately.	\$875.00
PDL610026DUPGRD	Component kit to upgrade a standard Trilogy cylindrical model to a PDL6100 Networx model. Kit includes a Networx outside HID Prox & digital keypad housing, inside housing with radio and a battery pack. Upgrade kit is designed to replace the existing and install in place same components, reusing the existing levers, cylinder, lock body & strike plate. Used with a Networx gateway purchased separately.	\$1,287.00
DL650026DUPGRD	Component kit to upgrade a standard Trilogy mortise lock model to a DL6500CR Networx model. Kit includes a Networx outside digital keypad housing, inside housing with radio, inside/outside levers and a battery pack. Upgrade kit is designed to replace the existing and install in place same components, reusing the existing cylinder, lock body & strike plate. Used with a Networx gateway purchased separately.	\$1,158.00
PDL650026DUPGRD	Component kit to upgrade a standard Trilogy mortise lock model to a PDL6500CR Networx model. Kit includes a Networx HID Prox & outside digital keypad housing, inside housing with radio, inside/outside levers and a battery pack. Upgrade kit is designed to replace the existing and install in place same components, reusing the existing, cylinder, lock body & strike plate. Used with a Networx gateway purchased separately.	\$1,493.00
PDL8200/26DUPGD	Component kit to upgrade a standard Trilogy cylindrical model to a PDL8200 iClass Networx model. Kit includes a Networx outside iClass Prox & digital keypad housing, inside housing with radio and a battery pack. Upgrade kit is designed to replace the existing and install in place same components, reusing the existing levers, cylinder, lock body & strike plate. Used with a Networx gateway purchased separately.	\$1,437.00

ArchiTech™ Series Network Locks

Ideal access control solution; elegantly blending advanced wireless access control convenience within any decor, in attractive, infinitely customizable designer locking form, in choice of trims and finishes.



Features:

- 5000 Users, 500 Scheduled Events & 40,000 Event Audit Trail
- Surface-Mount or Mortised - in Electronics and Battery Pack
- Lock available in Mortise and Cylindrical versions
- Real Time Clock - Uses 4 AA Batteries – 3 to 4-year battery life
- Operated via access card, fob, key fob etc
- DL-Windows Software for programming
- USB Radio Key Programming Method or Via Network Gateways
- Manual Card Enrollment Option for Quick Installation
- Wireless programming range: up to 20 ft. from lock

Specifications:

- ANSI / BHMA Grade 1 Certified, UL Listed 3 Hours
- Includes standard lever rose hardware design
- Compatible with all 300+ optional architectural trim / lever or knob designs
- Stainless steel latch, 2-3/4" backset
- Auto-Reverse lock body tested to 6 million cycles
- Lock Body - Self cleaning long life motor
- Door closure monitor / electronic deadbolt monitor
- Key override standard or high-Security
- Optional integrated door position indicator switch



Cylindrical

Standard model ordering. Consult factory for ordering assistance.

PRODUCT	LIST PRICE
N90S2195F26D	\$880.00
N90S1195F26D	\$880.00

ArchiTech Cylindrical Lever and Lever Prep Options

Options	195	295	395	495	Finish	Add-on	Cylinder Prep Code
Yale Conventional	Yes	No	No	No	26D, 10B	\$30.00	F7
Sargent Conventional	Yes	Yes	No	No	26D, 10B	\$30.00	F8
Corbin Conventional	Yes	Yes	No	No	26D, 10B	\$30.00	F9
Corbin 6 Pin IC	Yes	Yes	No	No	26D, 10B	\$30.00	F12
Corbin 7 Pin IC	Yes	No	No	No	26D, 10B	\$30.00	F13
Yale 6 Pin IC	Yes	Yes	No	No	26D, 10B	\$30.00	F14
Yale 7 Pin IC	Yes	No	No	No	26D, 10B	\$30.00	F15
Schlage 6 Pin IC	Yes	Yes	No	No	26D, 10B	\$30.00	F19
Sargent IC	Yes	Yes	No	No	26D, 10B	\$30.00	F20
Medeco IC (large format)	Yes	Yes	No	No	26D, 10B	\$30.00	F21

No up-charge for SFIC. Specify "RF" for SFIC

Note: Please consult factory for availability of other finishes. Round rose place only available with cylindrical version (3.5" diameter). IC core models: tail piece included, core not included.

ArchiTech N90L: Ideal for school & campus safety



LocDown Keyfobs -
Staffers lock down one, or all networked doors in seconds



- **Designer Wireless Access Control Networked Locks** include multi-technology ID reader access control convenience for any door and decor, with choice of handles, finishes and reader shape
- **Easily, securely networked via 802.11 or ethernet**, spanning a few or thousands of doors, in one building, a campus or multiple sites in an enterprise (also available in standalone model)
- **Emergency LocDown Keyfobs & Flashing Strobe Indicator** - In emergency, lockdown one or multiple locks globally with remote pocket sized keyfob. Lockdown indicator vividly flashes on the inside door, confirming lock activation and providing peace of mind to occupants
- **Programmable Lockdown/Unlock Privileges** - For added security, programmable user privileges can be varied by group, i.e., all users can be given global lockdown privileges, while only select users can have both lockdown & unlock privileges, etc.
- **Cylindrical ArchiTech Locks neatly, quickly retrofit any standard door lock, with easy surface mount electronics, for use in all applications** -Including wood and metal doors, for new and existing applications
- **Customizable** oval or square Access ID Reader, in black or silver and three levers to choose from - American 195, Crescent 295 & Titan 495 - See lever photos on next page.
- **Future-Proof Multi-Technology Access ID Credentials Replace Cumbersome Keys** – HID Prox, Mag Stripe, Smart Cards, PIV, keyfobs and remote buttons
- **Proven, Low Maintenance, Wireless Installation and Unsurpassed Battery-Life with Advanced Power-Saver circuit**, for years of use in even high-traffic areas, powered by 4 off-the-shelf AA Batteries. 3 to 4 years, typ.
- **Flexible System Monitoring, Control & Programming** – Program locally using a USB Gateway or remotely across a wireless network (using free Alarm Lock DL-WINDOWS Windows- based software). *Or, in Real-Time Enterprise platforms*, using either Continental Access CA4K[®], Lenel[®] OnGuard[®] or support via Software House[®] Connected Partner Program[®]

Lockdown Strobe Indicator flashes to confirm lock is in secure, lockdown mode



PRODUCT	LIST PRICE
N90L1195F26D	\$930.00
N90L2195F26D	\$930.00

ArchiTech Cylindrical Lever and Lever Prep Options

Options	195	295	395	495	Finish	Add-on	Cylinder Prep Code
Yale Conventional	Yes	No	No	No	26D, 10B	\$30.00	F7
Sargent Conventional	Yes	Yes	No	No	26D, 10B	\$30.00	F8
Corbin Conventional	Yes	Yes	No	No	26D, 10B	\$30.00	F9
Corbin 6 Pin IC	Yes	Yes	No	No	26D, 10B	\$30.00	F12
Corbin 7 Pin IC	Yes	No	No	No	26D, 10B	\$30.00	F13
Yale 6 Pin IC	Yes	Yes	No	No	26D, 10B	\$30.00	F14
Yale 7 Pin IC	Yes	No	No	No	26D, 10B	\$30.00	F15
Schlage 6 Pin IC	Yes	Yes	No	No	26D, 10B	\$30.00	F19
Sargent IC	Yes	Yes	No	No	26D, 10B	\$30.00	F20
Medeco IC (large format)	Yes	Yes	No	No	26D, 10B	\$30.00	F21

No up-charge for SFIC. Specify "RF" for SFIC

Note: Please consult factory for availability of other finishes. Round rose place only available with cylindrical version (3.5" diameter). IC core models: tail piece included, core not included.

Price Book 2019

AtchiTech Cylindrical (con't)

- 195: American Lever**
- 295: Crescent Lever**
- 495: Titan Lever**



The standard list price of a standard ArchiTech cylindrical lock is \$880.00 (American Lever, SC1 keyway)

- add \$100 onto list for iClass
- add \$100 onto list for Bluetooth
- add \$50 onto list for keying

How To Order for ArchiTech Cylindrical

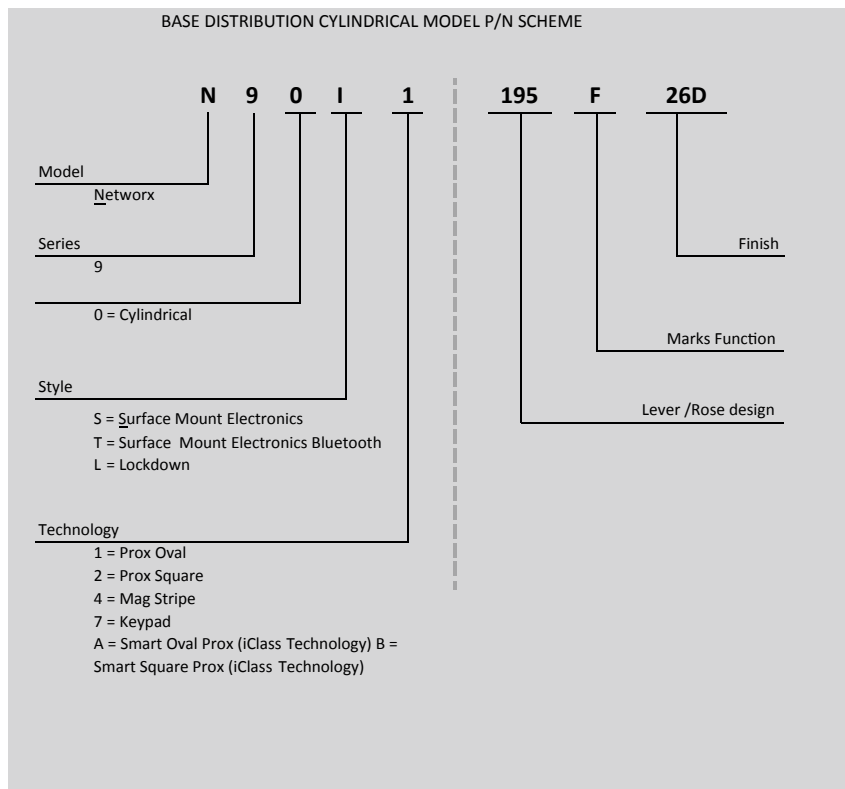

Functions for ArchiTech Mortise Locks

FD (Apartment) - Latch by knob/lever either side except when outside locked by stop-button or projected deadbolt. Latch deadlocked by auxiliary latch or deadbolt. Deadbolt and latch by key outside. Deadbolt by turn piece inside. Inside knob/lever retracts latch & deadbolt simultaneously, leaving outside locked.

EW (Storeroom) - Latch by knob/lever inside, key outside. Outside knob/lever always rigid. Auxiliary latch deadlocks latch. Inside always open.

AD (Automatic deadbolt) - Latch deadlocked by deadbolt automatically when door closes. Deadbolt and latch by key or credential outside. Inside knob/lever retracts latch & deadbolt simultaneously, leaving outside locked.

ArchiTech Mortise

Standard model ordering. Infinite custom models available for mortise version. Consult factory for ordering assistance.

PRODUCT	LIST PRICE
N95S2RX92FD26D	\$1,100.00
N95S1RW86FD26D	\$1,100.00

How To Order for ArchiTech Mortise

BASE DISTRIBUTION MORTISE MODEL P/N SCHEME

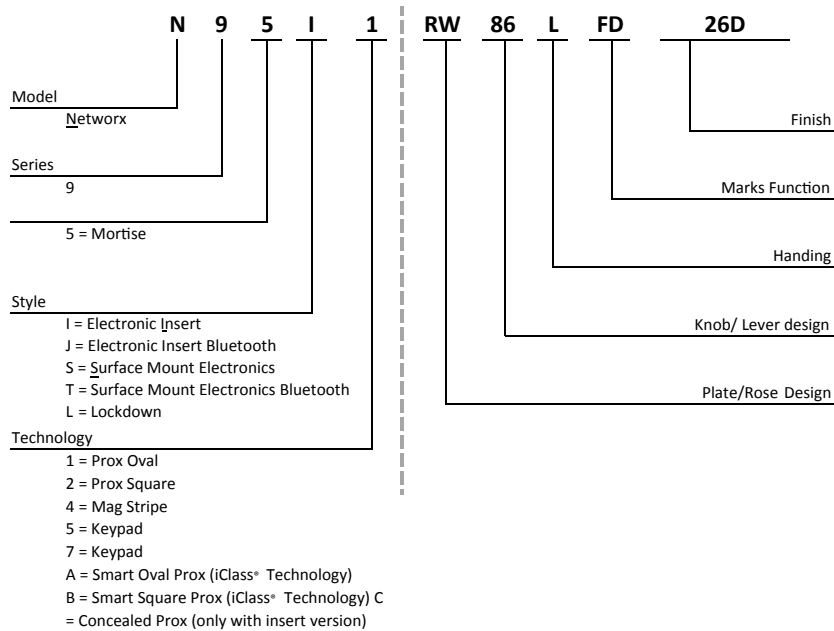

Price Book 2019





















ArchiTech Series – Mortise Lockset Options

1. Insert (N95I) or Surface mount (N95S) electronics
2. Oval, square, or mag reader
3. Features: Bluetooth or iClass
4. Function: storeroom (EW), Apartment (FD), or automatic deadbolt (AD)
5. Lever style (knob is also available)
6. Rose plate style
7. If escutcheon plate will be needed (consult factory)
8. Keying needed
9. Finish - currently 26D/32D and 10B is offered. Consult factory for other finishes.

The standard list price of a standard ArchiTech mortise lock is \$1,100.00 (American Lever, round rose)

- add \$100 onto list for iClass
- add \$100 onto list for Bluetooth
- add \$50 onto list for keying
- add \$50 onto list for any other lever design other than American (92)

Lever, knob and rose options. The code would be the number/letter underlined.

KNOBS	Round Knob <u>10</u>	Ball Knob <u>20</u>	Ball Knob <u>30</u>	Eclipse Knob <u>60</u>	ROSES	RR: 2-9/16" dia.	
						RW: 2-9/16" dia.	
	Stanhope Lever <u>44</u>	Madison Lever <u>52</u> Specify handing	Brompton Lever <u>55</u>	Monaco Lever <u>57</u> Specify handing		RQ: 2-1/4" dia.	
						RS: 2-1/4" dia.	
Towne Lever <u>72</u>	Maxwell Lever <u>77</u>	Omni Lever <u>78</u>	Plaza Lever <u>82</u> Specify handing	RX: 2-9/16"sq.		RK: 2-9/16"sq.	 Wrought  Forged
							
Dayton Lever <u>83</u> Specify handing	Crescent Lever <u>86</u>	American Lever <u>92</u>	Titan Lever <u>96</u>				
							

Additional notes:

- N95S (surface mount electronics, oval, square, and swipe (mag) reader available)
- N95I (insert electronics, oval and square reader available)
- N95J (insert electronics, Bluetooth, oval and square reader available)
- N95T (surface mount electronics, Bluetooth, oval, square and swipe (mag) reader available)

ArchiTech™ Series Networx Locks Parts and Accessories

AL-IME2	Ethernet connected gateway w/AC adapter to plug into standard wall outlet. Version 2 - allow use of expander	\$475.00
AL-IM2-80211	Wi-Fi gateway to connect to 802.11 network w/AC adapter to plug into standard wall outlet. Version 2 - allow use of expander	\$675.00
AL-IME2-POE	Power Over Ethernet, plus hardwire gateway interface capability. No AC Power required. Version 2 - allow use of expander	\$575.00
AL-IME2-EXP	Wireless expander designed to expand the coverage area of version 2 gateways. AC power required. Up to 7 expanders per version 2 gateway	\$250.00
AL-IME2-PIE	Plug-in wireless expander expands the coverage area of ver 2 gateways. Plugs into standard AC outlet. Up to 7 expanders per ver 2 gateway.	\$250.00
AL-PRE2	Prox Card Enroller - HID and iClass	\$590.00
ALID1326	Proximity Access Cards 100 Per Box	\$505.00
ALHID1336	Proximity, Magnetic Stripe and Photo ID cards 100 per box	\$1,030.00
ALHID1386	Proximity and Photo ID Card 100 per box	\$927.00
ALHID1391	MicroProx Tag 10 per box	\$82.00
ALHID1346	Proximity keyfob 10 per box	\$118.00
S6196	Networx Replacement Battery Pack	\$45.00
AL-IME-USB	USB Gateway	\$300.00
AL-NSM	Networx Signal Meter	\$296.00
AL-NSG	Networx Signal Generator	\$240.00
AL-PB	ArchiTech Power Booster	\$1,296.00

ArchiTech™ Series Networx Locks Mounted Samples

PRODUCT	LIST PRICE
N90S1195SK26D	consult factory
N95S1RW86SK32D	consult factory

Please consult factory for other ArchiTech sample types

iLock® App: Unlocks ArchiTech™ Bluetooth® Series Door Locks in seconds!



Introducing iLock®, the easy smartphone mobile solution for unlocking your ArchiTech™ Series Designer Access Control Locks from any smart device without the need to carry cumbersome ID cards or keys. Password protected access is secure through the use of Bluetooth LE™ and proprietary encryption. Additionally, an optional feature can be utilized, requiring a password for each unlock request.

The Key is Your Smartphone & More Secure Technology

Any Smart Device can be the Access Key: Much more than an ID card displayed on your



smartphone, for your security, ArchiTech & its iLock App are wirelessly linked together, each

supplying its portion of stored encrypted data to provide secure access without a key, fuss or worry, ensuring user identities. A unique combination of convenience and cloneproof peace of mind, the ArchiTech platform uses universally-compatible Bluetooth LE technology, so they can use any smart device to unlock ArchiTech on your door(s); and do so from afar, at a comfortable, customizable range of up to 30 feet away. For even greater security users can add an optional passcode, entered on their phone App. Coming soon: emailable digital eKeys for guests or service temporary access, too.



WEATHER-RESISTANT ALARMED PANIC LOCKS

Models 250, 260, 700, 710

Battery operated alarmed panic locks. All models (except 11A) feature deadbolt & deadlatch for extra security. Selectable 2-minute or constant alarm. 260/710. All models (except 11A) feature a 2-minute auto re-set on the alarm.

SPECIFICATIONS:

- Cover: Die-cast metal
- Push Bar: Extruded Aluminum channel and push bar
- Handed: All models non-handed except 11A
- Installation: Surface mounted for single or double doors
- Cylinder: Accepts most standard size rim cylinders for inside And outside key control (not included)
- Power: Uses 1 9v battery (included). Normal battery life 1 Year. Can be powered by AC power by using either PP100 or AC9.
- Lock bolt: 1" throw heavy die cast with reinforced Steel inserts.
- Alarm: Dual piezo siren measured at 95db



PRODUCT	FINISH	LIST PRICE
250WP (PADDLE)	US28	\$538.00
700WP (36" BAR)	US28, US312 & Red	\$654.00
700X48WP (48" BAR)	US28 & US312	\$654.00
710WP (36"BAR)	US28	\$677.00
CER-KD CER-12345 Rim Cylinder for Outside & Inside Key Control	Solid Brass Body Satin Chrome Face	\$32.00
730 Single Door Strike for 250,260,700 & 710	US28 & US312	\$47.00
732 Double Door Strike for 250,260,700 & 710	US28 & US312	\$47.00
44 Double Door Holder	Aluminum	\$131.00
707 Exterior Door Pull use on 250,260 700 & 710 only	Metallic Silver (MS) Metallic Bronze (MB)	\$133.00
711 Exterior Finger Pull	US28 & US312 Use on 250,260,700 & 710 only	\$32.00
767 Mounting Plate for Aluminum Glass Door	US28 & US312 Use on 250,260,700 & 710 only	\$22.00
PP100 Optional AC Power Supply	Aluminum	\$272.00
AC9 Optional AC Power Supply	Aluminum	\$77.00
S6173	Replacement WP battery	\$37.00

ALARMED PANIC DEVICES

Models 250, 260, 700, 710 & 11A– Battery operated alarmed panic locks. All models (except 11A) feature deadbolt & deadlatch for extra security. Selectable 2-minute or constant alarm. 260/710. All models (except 11A) feature a 2-minute auto re-set on the alarm.

SPECIFICATIONS:



Cover: Die-cast metal
 Push Bar: Extruded Aluminum channel and push bar
 Handed: All models non-handed except 11A
 Installation: Surface mounted for single or double doors
 Cylinder: Accepts most standard size rim cylinders for inside And outside key control (not included)
 Power: Uses 1 9v battery (included). Normal battery life 1 Year. Can be powered by AC power by using either PP100 or AC9.
 Lock bolt: 1” throw heavy die cast with reinforced Steel inserts.
 Alarm: Dual piezo siren measured at 95db



PRODUCT	FINISH	LIST PRICE
250 (PADDLE)	US28	\$474.00
260 (PADDLE)	US28	\$517.00
700 (36” BAR)	US28, US312 & Red	\$573.00
700X48 (48” BAR)	US28 & US312	\$613.00
710 (36”BAR)	US28	\$613.00
710X48 (48”BAR)	US28	\$628.00
11A	Deadbolt only exit lock. Handed order 11A or 11ALH. Use BP6 Battery.	\$598.00

ACCESSORIES

CER-KD CER-12345 Rim Cylinder for Outside & Inside Key Control	Solid Brass Body Satin Chrome Face	\$32.00
730 Single Door Strike for 250,260,700 & 710	US28 & US312	\$47.00
732 Double Door Strike for 250,260,700 & 710	US28 & US312	\$47.00
K24A	11A Single door strike	\$37.00
K210A	11A Strike for in-swing doors	\$55.00
44 Double Door Holder	Aluminum	\$131.00
22 Emergency Exit Pull (250/260/11A)	Aluminum	\$92.00
707 Exterior Door Pull use on 250,260 700 & 710 only	Metallic Silver (MS) Metallic Bronze (MB)	\$133.00
711 Exterior Finger Pull	US28 & US312 Use on 250,260,700 & 710 only	\$32.00
767 Mounting Plate for Aluminum Glass Door	US28 & US312 Use on 250,260,700 & 710 only	\$22.00
PP100 Optional AC Power Supply	Aluminum	\$272.00
AC9 Optional AC Power Supply	Aluminum	\$77.00
9936	Used to mount 11A on 36” glass door	\$94.00
9948	Used to mount 11A on 48” glass door	\$99.00
261	Current Transfer	\$72.00
BP6	Replacement battery for 11A	\$37.00



DOOR ALARMS

PG10, PG21 & PG30 SERIES – Battery operated surface mounted door alarms. Alarms magnetically activated. Easy to install. Convenient plug-in “No cut” jumpers.

SPECIFICATIONS:

- Power: PG21, PG30 use 9v battery (supplied). PG10 & LL1 use BP6 (supplied). BP6 must be purchased from Alarm Lock. AC power supply can also be used as a battery back up (see below).
- Alarm: Dual piezo siren measured at 95db.
- Cylinder: Accepts most 1¼” mortise cylinder used for interior activation (not supplied) and standard size rim cylinder used for exterior activation (not supplied).
- Installation: Surface mounted for single or double doors.
- Cover: Die cast metal.



PRODUCT	DESCRIPTION	LIST PRICE
PG10	Available in aluminum finish uses BP6 Battery replaced only through Alarm Lock	\$298.00
LL1	Same as PG10 with strobe light on top.	\$309.00
PG21MS PG21MB	Available in metallic silver and metallic bronze. Uses 9v battery.	\$298.00
PG21MSS/PG21MBS	Available in metallic silver and metallic bronze. Uses 9v battery with yellow strobe on top for noisy areas	\$366.00
PG30MS PG30MB	Available in metallic silver and metallic bronze. No cylinders required. All exit, entry and security levels programmed through keypad. 3 security levels, master, management and passage. Use 9v battery.	\$355.00
PG30KPD	Exterior keypad used with PG30 only.	\$205.00
CEM-KD CEM-12345	Standard mortise cylinder for interior activation. Solid brass body, satin chrome face	\$32.00
CER-KD CER-12345	Standard rim cylinder for exterior activation. Solid brass body, satin chrome face.	\$32.00
PP100	AC battery back-up complete with armored cable and housing.	\$272.00
AC9	AC battery back-up housing only	\$77.00
BP6	Replacement battery for PG10 & LL1	\$37.00

DELAYED EGRESS PANIC LOCKS

715 Series - Stand alone delayed egress panic lock. 15 second delayed latch, instant alarm. Instant egress in case of emergency or fire. Meets NFPA 101 Life Safety Code. Includes monitoring output for secondary siren , CCTV or remote monitoring. Smoke detector input.

SPECIFICATIONS:

Cover: Die cast metal
 Push bar: Extruded aluminum push bar and channel
 Handed: Non-handed
 Installation: Surface mounted for single or double doors
 Cylinder: Accepts most standard size rim cylinder used for Inside and outside key control
 Power: AC powered with 9v battery back-up for siren. Transformer And armored cable included
 Lock bolt: 1" throw heavy die cast with reinforced steel inserts
 Alarm: Dual piezo siren measured at 95db



PRODUCT	DESCRIPTION	LIST PRICE
715X28X88	15 second delayed egress lock. Aluminum finish with monitoring output. 33" bar.	\$1,078.00
715x28x88x48	15 second delayed egress lock. Aluminum finish with monitoring output. 48" bar	\$1,091.00
CER-KD CER-12345	Standard rim cylinder	\$32.00
725x28	Single door strike (included with unit)	\$55.00
735x28	Double door strike (not included with unit)	\$55.00
SWK-715	Surface wiring kit for wood or glass doors	\$94.00
767x28	Metal mounting plate for glass doors	\$22.00
277-12	277v transformer to wire 715 from Exit Sign	\$65.00
271	Armored cable	\$56.00

ELECTRIC DEADBOLTS

Models 103 & 104 Fail-safe or fail-secure electric deadbolts. Available In 12v or 24v AC or DC. Perfect for use on narrow stile Doors. Complete with angle, mortise or flush mount strikes. Use with standard key or push button switch.

SPECIFICATIONS:

Cover: Molded aluminum
 Power : Requires 400 mA for 24v, 800mA for 12v unit
 Deadbolt: Powered by a continuous duty solenoid. 5/8" diameter And 5/8" projection.



PRODUCT	DESCRIPTION	LIST PRICE
103	24v AC or DC. Includes three strikes and magnets. Fail-safe	\$360.00
103x12	12v AC or DC. Includes three strikes and magnets. Fail-safe	\$424.00
104RA	24v AC or DC. Includes three strikes and magnets. Fail-secure	\$429.00
104x12	12v AC or DC. Includes three strikes and magnets. Fail-secure	\$474.00
221 / 241	24v Plug-in style transformers	\$55.00
222	24v Wire-in style transformer	\$55.00

Price Book 2019

REMOTE RELEASE MAGNET

RR-PM1200 SERIES – Stand alone remote operated infra-red mag lock. Allows remote Lock control by a transmitting keyfob. Infra-red signal is detectable From interior and exterior sides of the door. Keyfob will operate From 10 feet on exterior side and 35 feet from interior side.

SPECIFICATIONS:

Magnet: 1200lb 12v DC magnet
 Power: Includes 12v AC plug in transformer. A 12v DC power supply
 Can be utilized (not included)
 Keyfob: Single button, dual LED infra-red transmitting. Up to 100 keyfobs
 Can be programmed into a single magnet.
 Programming: Each keyfob must be presented to the magnet to enroll keyfob ID into Software.



PRODUCT	DESCRIPTION	LIST PRICE
RR-PM1200PAK	Includes 1 1200lb remote magnet, one AL-REMOTE keyfob and one 12v AC transformer	\$642.00
RR-PM1200	1200lb remote magnet	\$568.00
AL-REMOTE	Remote keyfob	\$66.00

POWER MAGNETS AND REQUEST TO EXIT BUTTONS

PRODUCT	DESCRIPTION	LIST PRICE
PM600BI	600lb magnetic lock field selectable 12/24v DC 9 7/8" x 1 11/16" x 1" Aluminum finish	\$332.00
PM600L	600lb magnetic lock field selectable 12/24v DC 9 7/8" x 1 11/16" x 1" Aluminum finish L.E.D. indicator & door bond sensor for remote monitoring	\$390.00
PM1200	1200lb magnetic lock field selectable 12/24v DC 9 7/8" x 1 11/16" x 1" Aluminum finish	\$350.00
PM1200SL PM1200SL40 (dark bronze)	1200lb magnetic lock field selectable 12/24v DC 9 7/8" x 1 11/16" x 1" Aluminum finish L.E.D. indicator & door bond sensor for remote monitoring	\$406.00
PM1200SLBI	1200lb magnetic lock field selectable 12/24v DC 21" x 1 11/16" x 1" Aluminum finish L.E.D. indicator & door bond sensor for remote monitoring for use on double doors	\$734.00
PM120040	1200lb magnetic lock field selectable 12/24v DC 9 7/8" x 1 11/16" x 1" dark bronze finish	\$396.00
PM1200SLBI40	1200lb magnetic lock field selectable 12/24v DC 21" x 1 11/16" x 1" dark bronze finish L.E.D. indicator & door bond sensor for remote monitoring for use on double doors	\$734.00
PE1	Round red exit button non-illuminate Standard switch plate	\$133.00
PE2	Square green illuminated exit button Standard switch plate	\$133.00
PE2S	Square green illuminated exit button Narrow switch plate	\$131.00
PMA-ANGL1	Angle bracket 1 1/2 x 10 1/2	\$48.00
PMA-ANGL2	Angle bracket adjustable 1 1/2 x2 3/8x 10 1/2	\$92.00
PMA-ANGL3	Angle bracket adjustable 1 3/8x2 3/8x10 1/2	\$92.00
PMA-FILL1	Filler plate 10 1/2 x 3/4 x 5/8	\$38.00

Note: Remote release and Power mag and accessories follow the Trilogy discounts.



POWER MAGNETS AND REQUEST TO EXIT BUTTONS (cont'd)

PRODUCT	DESCRIPTION	LIST PRICE
PMA-FILL2	Filler plate 10 ½ x ¾ x ½	\$38.00
PMA-Z1	Z bracket adjustable use with PM600B1 Series	\$177.00
PMA-Z2	Z bracket adjustable use with PM1200 series	\$289.00
PMA-ARMH1	Armature plate 7 ¼" x 1 ½" x 19/32"	\$172.00
PMA-ARMH2	Armature plate 7 ½" x 2 7/16" x 19/32"	\$188.00

ALARM LOCK SYSTEMS, INC. WARRANTY/RETURN POLICY

Alarm Lock Systems Inc. warrants its products to be free from manufacturing defects in material and workmanship. The length of said warranty is 24 months on all products from the date of manufacture.

Any customer may get an over-the-counter exchange with the original seller (distributor) for any Alarm Lock product failing to operate properly.

For those customers who have direct accounts with Alarm Lock, please follow this procedure to return product for warranty replacement:

- 1. Email your request to: returns@alarmlock.com**
- 2. In order to receive a return authorization number, you must provide the date code of the product.**
- 3. The 4-digit date code sticker is the actual expiration date of the warranty.**
- 4. Any out of warranty product returned to the factory will be scrapped and is not returnable.**
- 5. If said product is found not to be operating properly because of a factory defect and is within the warranty period, Alarm Lock will issue a product replacement.**

If you experience a problem with any Alarm Lock product, you may contact Alarm Lock's Technical Support directly at 1 800 252-5625.

All prices published are suggested list prices in US Dollars. Some specifications are preliminary and subject to change without prior notice. Not responsible for typographical errors. Alarm Lock Systems, LLC, is a Division of Napco Security Technologies, Inc. (NASDAQ:NSSC) © Alarm Lock Systems, LLC, 9.16

Notes

Notes

Alarm Lock Systems, Inc.
345 Bayview Ave
Amityville, NY 11701
1 800 252-5625
1 631 789-3383
www.alarmlock.com

ALA132B.1

7/19